

# JVC



## VIDEO CASSETTE RECORDER

## ENGLISH

# HR-J255EA

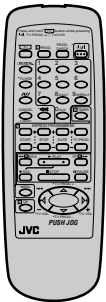

**G-CODE** **VHS**  
PAL

## INSTRUCTIONS



### CONTENTS

<b>SAFETY FIRST</b>	<b>2</b>
Safety Precautions .....	2
<b>INSTALLING YOUR NEW RECORDER 3</b>	
Basic Connections .....	3
<b>INITIAL SETTINGS</b>	<b>4</b>
Video Channel Set .....	4
Auto Set Up .....	6
Clock Set .....	8
On-Screen Displays .....	9
<b>PLAYBACK</b>	<b>10</b>
Basic Playback .....	10
Playback Features .....	11
<b>RECORDING</b>	<b>14</b>
Basic Recording .....	14
Recording Features .....	15
B.E.S.T. Picture System .....	16
<b>TIMER RECORDING</b>	<b>18</b>
G-CODE Setup .....	18
G-CODE Timer Programming .....	20
Express Timer Programming .....	22
<b>EDITING</b>	<b>26</b>
Edit To Another Video Recorder .....	26
Edit From A Camcorder Or Another Video Recorder .....	27
<b>TUNER SET</b>	<b>28</b>
<b>TROUBLESHOOTING</b>	<b>32</b>
<b>QUESTIONS AND ANSWERS</b>	<b>34</b>
<b>INDEX</b>	<b>35</b>
<b>SPECIFICATIONS</b>	<b>38</b>

# Safety Precautions

The rating plate and the safety caution are on the rear of the unit.

**WARNING: DANGEROUS VOLTAGE INSIDE**

**WARNING: TO PREVENT FIRE OR SHOCK HAZARD, DO NOT EXPOSE THIS UNIT TO RAIN OR MOISTURE.**

## CAUTION

- When you are not using the recorder for a long period of time, it is recommended that you disconnect the power cord from the mains outlet.
- Dangerous voltage inside. Refer internal servicing to qualified service personnel. To prevent electric shock or fire hazard, remove the power cord from the mains outlet prior to connecting or disconnecting any signal lead or aerial.

## Warning on lithium battery

The battery used in this device may present a fire or chemical burn hazard if mistreated. Do not recharge, disassemble, heat above 100°C or incinerate. Replace battery with Panasonic (Matsushita Electric), Sanyo, Sony or Maxell CR2025; use of another battery may present a risk of fire or explosion.

- Dispose of used battery promptly.
- Keep away from children.
- Do not disassemble and do not dispose of in fire.

## IMPORTANT

- Please read the various precautions on this page before installing or operating the recorder.
- It should be noted that it may be unlawful to re-record pre-recorded tapes, records, or discs without the consent of the owner of copyright in the sound or video recording, broadcast or cable programme and in any literary, dramatic, musical, or artistic work embodied therein.

The POWER  $\text{O/I}$  button does not completely shut off mains power from the unit, but switches operating current on and off. "  $\text{O}$  " shows electrical power standby and "  $\text{I}$  " shows ON.

Video tapes recorded with this video recorder in the LP (Long Play) mode cannot be played back on a single-speed video recorder.

**Failure to heed the following precautions may result in damage to the recorder, remote control or video cassette.**

1. **DO NOT** place the recorder . . .
  - ... in an environment prone to extreme temperatures or humidity.
  - ... in direct sunlight.
  - ... in a dusty environment.
  - ... in an environment where strong magnetic fields are generated.
  - ... on a surface that is unstable or subject to vibration.
2. **DO NOT** block the recorder's ventilation openings.
3. **DO NOT** place heavy objects on the recorder or remote control.
4. **DO NOT** place anything which might spill on top of the recorder or remote control.
5. **AVOID** violent shocks to the recorder during transport.

## MOISTURE CONDENSATION

Moisture in the air will condense on the recorder when you move it from a cold place to a warm place, or under extremely humid conditions—just as water droplets form in the surface of a glass filled with cold liquid. Moisture condensation on the head drum will cause damage to the tape. In conditions where condensation may occur, keep the recorder turned on for a few hours to let the moisture dry.

## ABOUT HEAD CLEANING

Accumulation of dirt and other particles on the video heads may cause the playback picture to become blurred or interrupted. Be sure to contact your nearest JVC dealer if such troubles occur.

### Auto Head Cleaner

A built-in head cleaner automatically cleans the video heads and head drum whenever a tape is loaded or unloaded to reduce head clogging.



# G-CODE

- Only cassettes marked "VHS" can be used with this videorecorder.
- HQ VHS is compatible with existing VHS equipment.
- G-CODE is a registered trademark of Gemstar Development Corporation. The G-CODE system is manufactured under license from Gemstar Development Corporation.

# Basic Connections

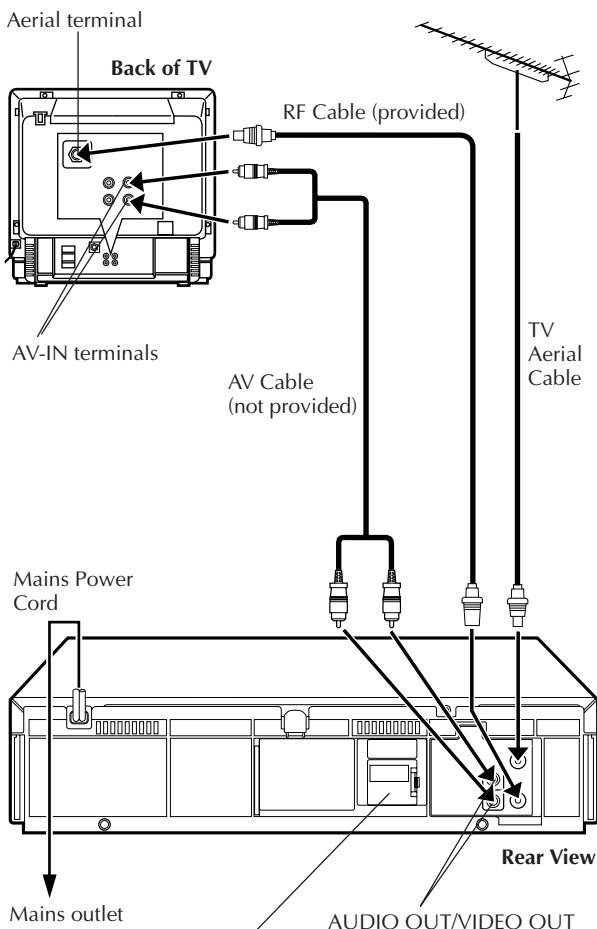

Connect the power plug to an AC outlet before installing the lithium battery. [pg. 5](#)

It's essential that your video recorder be properly connected. Follow these steps carefully. THESE STEPS MUST BE COMPLETED BEFORE ANY VIDEO OPERATION CAN BE PERFORMED.

- 1 **CHECK CONTENTS**  
Make sure the package contains all of the accessories listed in "Specifications" ([pg. 38](#)).
- 2 **SITUATE RECORDER**  
Place the recorder on a stable, horizontal surface.
- 3 **CONNECT RECORDER TO TV**  
The connection method you use depends on the type of TV you have.
  - RF CONNECTION**
    - To Connect To A TV With NO AV Input Terminals . . .
      - a- Disconnect the TV aerial cable from the TV.
      - b- Connect the TV aerial cable to the ANT. IN jack on the rear panel of the recorder.
      - c- Connect the provided RF cable between the RF OUT jack on the rear panel of the recorder and the TV's aerial terminal.
  - AV CONNECTION**
    - To Connect To A TV With AV Input Terminals . . .
      - a- Connect the aerial, recorder and TV as per "RF CONNECTION".
      - b- Connect an optional AV cable between the AUDIO OUT and VIDEO OUT connectors on the rear panel of the recorder and the TV's AV-IN terminals .
- 4 **CONNECT RECORDER TO MAINS**  
Plug the end of the mains power cord into a mains outlet.

**ATTENTION**  
If you have finished all the necessary connections, go to "Video Channel Set" on page 4, then perform Auto Set Up on page 6; do NOT press the button on the recorder/remote control to turn on the recorder's power before you start Auto Set Up.

# Video Channel Set

Video Channel (RF Output Channel) is the channel on which your TV receives picture and sound signals from the video recorder through the RF cable.

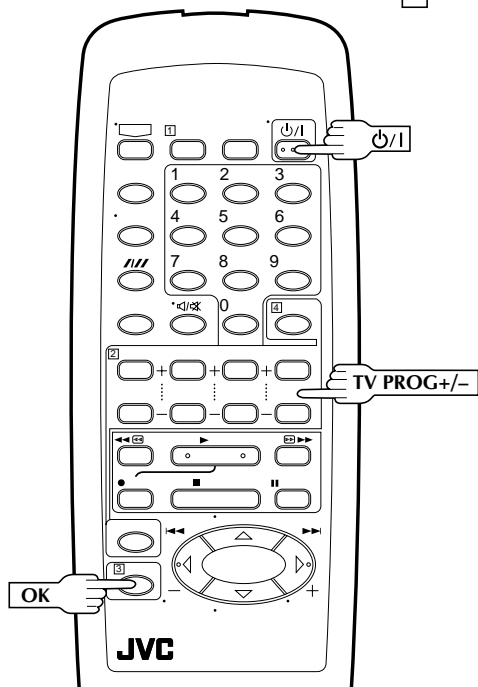
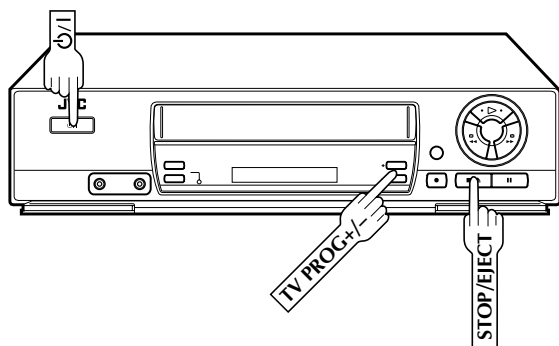

## TEST SIGNAL

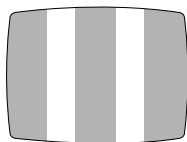

The channel on which the screen to the left appear clearly in step 3 is your Video Channel.

To view picture signals from the video recorder, set your TV to the Video Channel.

If you have connected the video recorder to your TV via the provided RF cable only (RF connection) – Go to "With RF Connection" below.

If you have connected the video recorder to your TV via both the provided RF cable and an AV cable (AV connection) – Go to "With AV Connection" on next page.

## With RF Connection

### IMPORTANT:

Before performing the following steps, make sure the recorder's power is off and there is no cassette inserted in the recorder.

## ACCESS VIDEO CHANNEL SET MODE

1 Hold down **STOP/EJECT** on the recorder until the display panel shows the following.

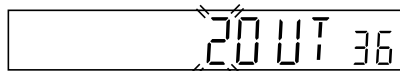

## SELECT TV SYSTEM

2 Press **TV PROG +** or **-** to set appropriate TV system that matches the system of TV being used (refer to the table below).



1 : B/G 2 : H

Major Countries	TV System
New Zealand, Kuwait, U.A.E., Indonesia, Singapore, Thailand, Malaysia, Iran, Saudi Arabia, Egypt, Morocco, Lebanon, Iraq	B/G
Australia	H

## SET VIDEO CHANNEL

3

Set your TV to UHF channel 36.

- If the two vertical white bars appear clearly on the screen as shown in the illustration (➔ "TEST SIGNAL" on page 4), press **OK** and then go to step 4.
- If the two vertical white bars do not appear clearly, press **OK** and then **TV PROG +** or **-** to set the video recorder to a vacant channel between 28 and 60 which is not occupied by any local station in your area.

(Ex.) If channel 50 is available in your area

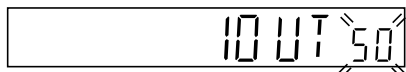

Then set your TV to UHF channel 50 and check if the two vertical white bars appear clearly on the screen; if so, go to step 4. If not, re-set the video recorder to another vacant channel and try again.

### NOTES:

- If you set the video recorder to a channel which is occupied by a local station or has neighbouring channels that are occupied by local stations, the picture reception quality will be affected and some interference noise will appear on the TV screen. Be sure to select a vacant channel which has no broadcast on neighbouring channels.
- If you cannot obtain the two vertical white bars clearly with any channel between 28 and 60, consult your JVC dealer.

## EXIT VIDEO CHANNEL SET MODE

4

Press **⏻/I** to finish the setting.

## With AV Connection

### IMPORTANT:

Before performing the following steps, make sure the recorder's power is off and there is no cassette inserted in the recorder.

## ACCESS VIDEO CHANNEL SET MODE

1

Hold down **STOP/EJECT** on the recorder until the display panel shows the following.

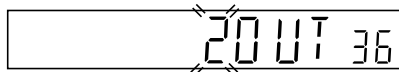

## SET VIDEO CHANNEL

2

Press **OK**, then press **TV PROG -** until the display panel shows the following.

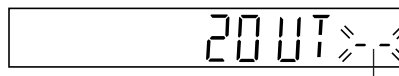

Now the video channel is set to off (--).

## EXIT VIDEO CHANNEL SET MODE

3

Press **⏻/I** to finish the setting.

To view picture signals from the video recorder, set your TV to its AV mode.

Be sure to connect the power plug to an AC outlet first before installing the lithium battery; otherwise, the battery's service life will be drastically shortened.

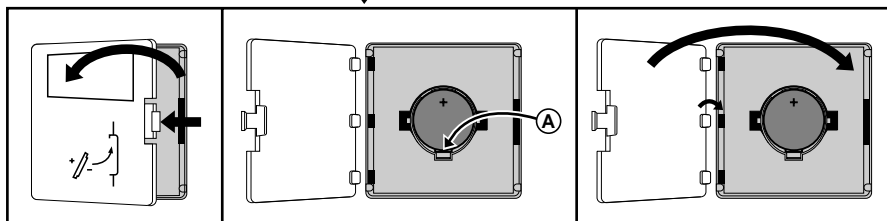
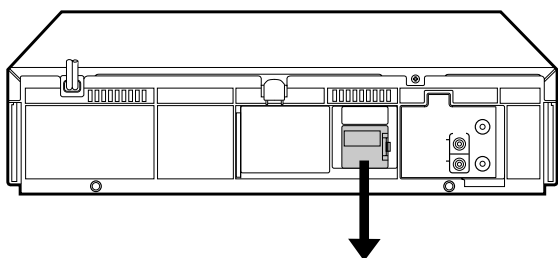

### Installing/Removing the lithium battery

- 1 Make sure that the power plug is connected to an AC outlet and turn off the VCR power.
- 2 Open the battery cover while pressing the release tab as illustrated.
- 3 Insert a lithium battery with the plus (+) side up and push it in.
  - To remove the lithium battery, press the latch (A) downward using a pointed non-metallic object, then pull out the lithium battery.
- 4 Close the battery cover until it clicks in place.

# Auto Set Up

## Auto Channel Set

Before starting, make sure of the following:

- The TV aerial cable should be connected to the recorder.
- The recorder's mains power cord should be connected to a mains outlet. [☞ pg. 3](#)
- The "Video Channel Set" procedure should be done first and the TV should be set to its AV mode (with AV connection [☞ pg. 5](#)) or video channel (with RF connection [☞ pg. 4](#)).

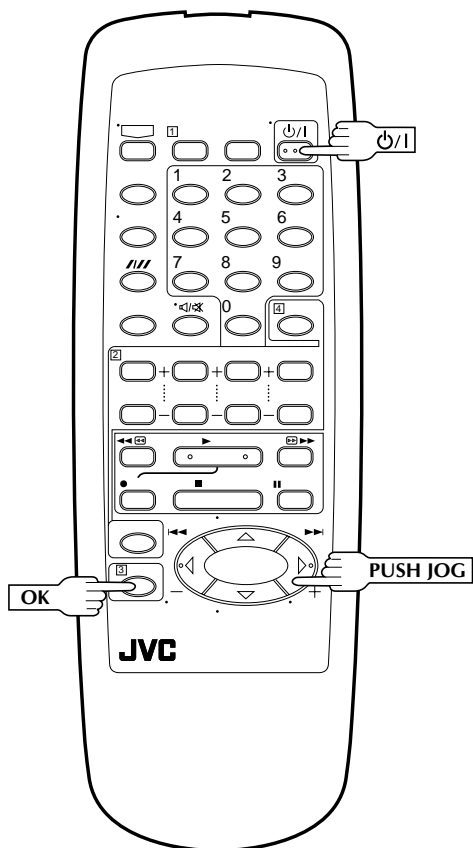
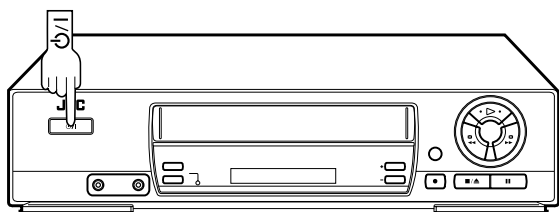

The Auto Set Up function simplifies installation by guiding you through the procedures of setting the language, clock and tuner channels — simply follow the on-screen menus that appear when the  $\phi/1$  button is first pressed to power on the recorder after you plug the mains power cord into a mains outlet.

### IMPORTANT

- Don't press any buttons on the recorder or remote that are not directly related to the step you are performing while Auto Set Up is in progress.
- If you perform Auto Set Up successfully during installation, there's no need to separately perform the Clock Set or Channel Set procedures, but if adjustments become necessary they can be performed as follows:
  - To reset or adjust the time [☞ pg. 8](#)
  - To add/delete channels manually [☞ pg. 29](#)
  - To reset the tuner after moving to a different location [☞ pg. 28](#)

## PERFORM AUTO SET UP

1

Press  $\phi/1$ .

- The Clock Set screen appears.

2

### SET TIME

Press **PUSH JOG**  $\Delta \nabla$  to set the time, then press **OK** or **PUSH JOG**  $\triangleright$ .

- Press and hold either button to delay or advance the time by 30 minutes.

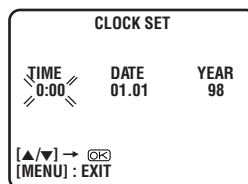

3

### SET DATE

Press **PUSH JOG**  $\Delta \nabla$  to set the date, then press **OK** or **PUSH JOG**  $\triangleright$ .

- Press and hold either button to change the date by 15 days.

4

### SET YEAR

Press **PUSH JOG**  $\Delta \nabla$  to set the year, then press **MENU**.

## 5 START AUTO CHANNEL SET

Press **OK** or **PUSH JOG** ▸.

- The Auto Set Up function scans all the channels that are receivable by your recorder. It then automatically assigns each receivable channels to the **TV PROG** buttons. It skips non-receivable channels.
- As Auto Set Up progresses, the "■" mark on the screen moves from left to right. (See below.)

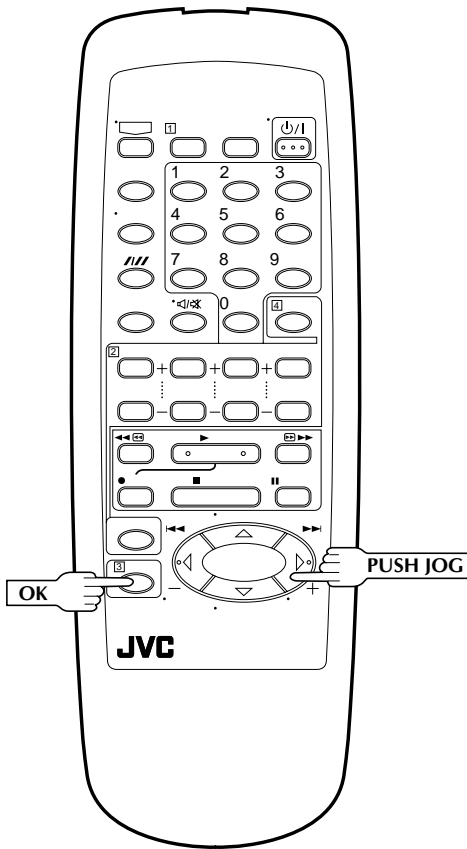

**DO NOT** press any button on the recorder or remote control while Auto Set Up is in progress.

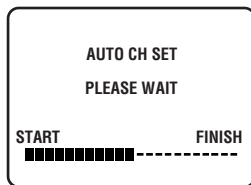

**During Auto Set Up**  
"PLEASE WAIT" blinks on the screen and "Auto" blinks on the front display panel.

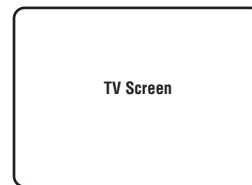

When Auto Set Up is completed, the lowest position number will appear on the front display panel.

### NOTES:

- If you perform Auto Set Up when the aerial cable is not connected properly, "SCAN COMPLETED -NO SIGNAL-" appears on the screen. When this happens, make sure of the aerial connection and press **OK**; Auto Set Up will take place again.
- If there is a power cut, or if you press **⏻** or **MENU** while Auto Set Up is in progress, Auto Set Up will be interrupted; be sure to turn off the recorder power once and try again.
- If you want to set the tuner manually such as to add or skip channels, to swap channel positions, or to fine-tune channels, see pg. 29–31.

# Clock Set

Turn on the TV and select the VIDEO channel (or AV mode).

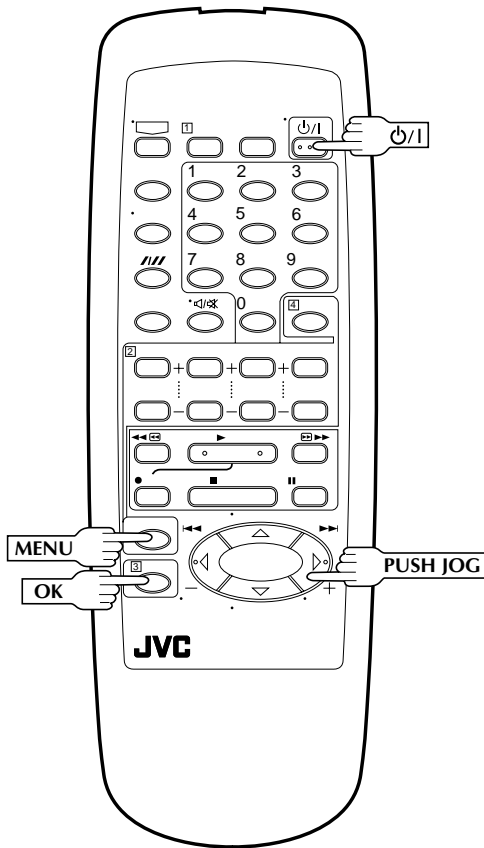

## 1 TURN THE RECORDER ON

Press **⏻/1**.

## 2 ACCESS MAIN MENU SCREEN

Press **MENU**.

## 3 ACCESS INITIAL SET SCREEN

Press **PUSH JOG**  $\Delta\nabla$  to place the pointer next to "INITIAL SET", then press **OK** or **PUSH JOG**  $\triangleright$ .

## 4 ACCESS CLOCK SET SCREEN

Press **PUSH JOG**  $\Delta\nabla$  to place the pointer next to "CLOCK SET", then press **OK** or **PUSH JOG**  $\triangleright$ . The Clock Set screen appears.



## 5 SET TIME

Press **PUSH JOG**  $\Delta\nabla$  to set the time, then press **OK** or **PUSH JOG**  $\triangleright$ .

- Press and hold either button to delay or advance the time by 30 minutes.

## 6 SET DATE

Press **PUSH JOG**  $\Delta\nabla$  to set the date, then press **OK** or **PUSH JOG**  $\triangleright$ .

- Press and hold either button to change the date by 15 days.

## 7 SET YEAR

Press **PUSH JOG**  $\Delta\nabla$  to set the year.

## 8 START CLOCK OPERATION

Press **MENU**.

### NOTE:

If the year digits are automatically cleared, it is possible that you have input 29th February for a non-leap year. Input the correct data.



# On-Screen Displays

Turn on the TV and select the VIDEO channel (or AV mode).

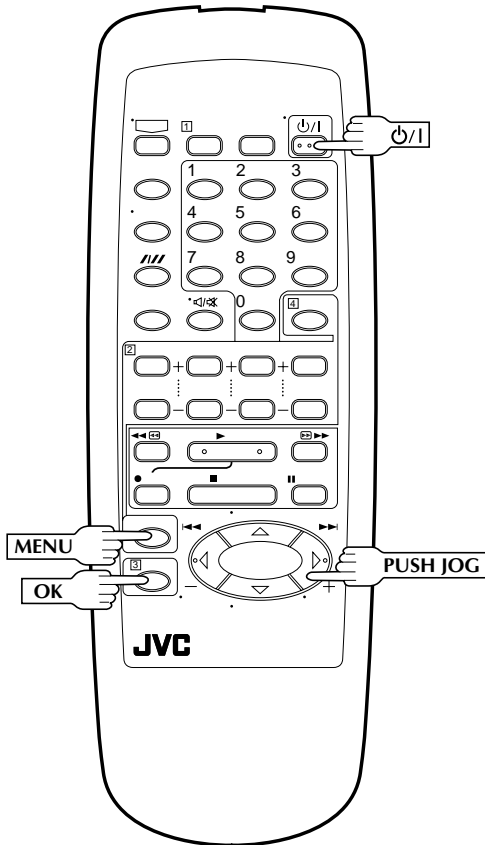

You can choose whether or not to have various operational indicators appear on screen, by setting this function ON or OFF.

## 1 TURN ON THE RECORDER

Press **⏻/I**.

## 2 ACCESS MAIN MENU SCREEN

Press **MENU**.

## 3 ACCESS FUNCTION SET SCREEN

Place the pointer next to "FUNCTION SET" by pressing **PUSH JOG**  $\Delta\nabla$ , then press **OK** or **PUSH JOG**  $\triangleright$ .

## 4 ENABLE/DISABLE ON-SCREEN DISPLAY

The default setting is "ON", so if you want on-screen displays, leave the setting as it is and go to step 5. If you don't want the displays to appear, press **PUSH JOG**  $\Delta\nabla$  to place the pointer next to "O.S.D." and press **OK** or **PUSH JOG**  $\triangleright$  to set to "OFF".

FUNCTION SET	
<b>AUTO TIMER</b>	OFF
<b>O.S.D.</b>	ON
<b>B.E.S.T.</b>	ON
<b>AUTO SP→LP TIMER</b>	OFF
[ $\Delta/\nabla$ ] → [OK] [MENU] : EXIT	

## 5 RETURN TO NORMAL

Press **MENU**.

### NOTES:

- When you use this recorder as the player for editing, be sure to set "O.S.D." to "OFF" before starting.
- During playback, the operation mode indicators may be disturbed depending on the type of tape being used.

The superimposed indication on the TV screen tells you what the recorder is doing.

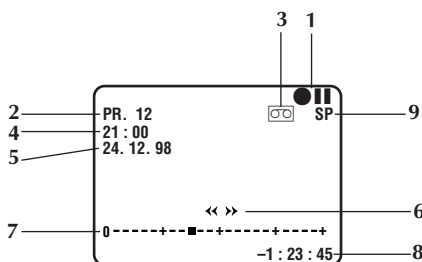

- 1- Operation mode indicators
- 2- Channel position number/Aux. indicator (F-1)
- 3- Cassette loaded mark
- 4- Clock display
- 5- Current day/month/year
- 6- Tape direction
- 7- Tape position indicator (see pg. 13)
- 8- Counter display
- 9- Tape speed SP/LP/EP

# Basic Playback

Turn on the TV and select the VIDEO channel (or AV mode).

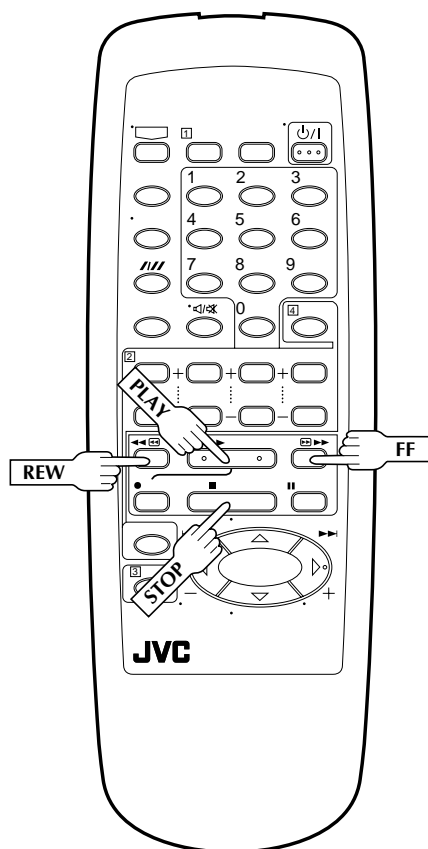
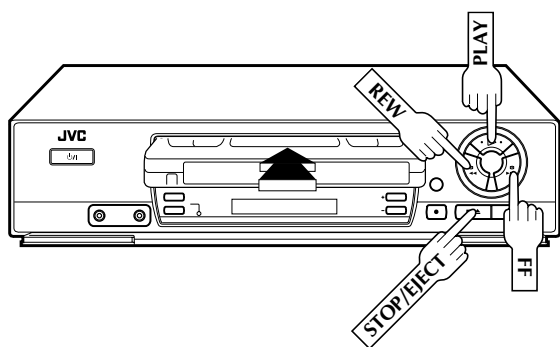

The easiest, most basic operation possible with your video recorder is tape playback. Already-recorded signals on a video tape are read by your video recorder and displayed on your TV just like a TV programme.

1

## LOAD A CASSETTE

Make sure the window side is up, the rear label side is facing you and the arrow on the front of the cassette is point toward the recorder. Don't apply too much pressure when inserting.

- The recorder power comes on automatically and the counter is reset to 0:00:00.
- If the record safety tab has been removed, playback begins automatically. (☞ pg. 14)

2

## FIND PROGRAMME START POINT

If the tape is advanced past the start point, press **REW**. To go forward, press **FF**.

3

## START PLAYBACK

Press **PLAY**. "BEST" appears blinking in the recorder's display panel during automatic tracking. (☞ pg. 16)

4

## STOP PLAYBACK

Press **STOP** on the remote or **STOP/EJECT** on the recorder's front panel. Then press **STOP/EJECT** to remove the cassette.

### Usable cassettes

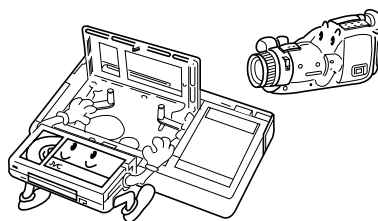

- Compact VHS camcorder recordings can be played on this video recorder. Simply place the recorded cassette into a VHS Cassette Adapter and it can be used just like any full-sized VHS cassette.
- This video recorder can record on regular VHS and Super VHS cassettes. However, it will record and play back regular VHS signals only. It is not possible to play back a recorded Super VHS tape.

# Playback Features

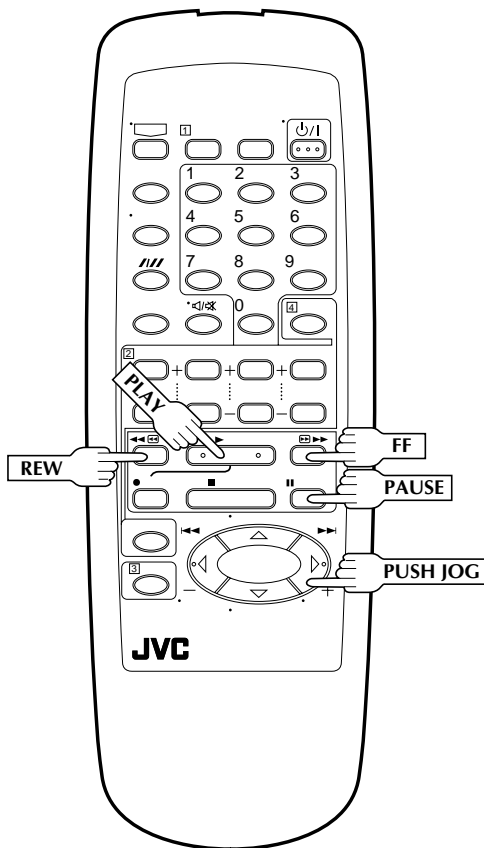
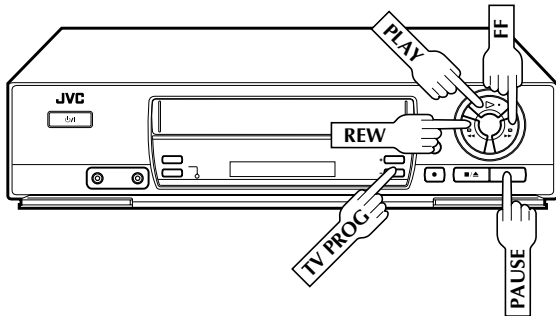

## ATTENTION

In the search, still, slow-motion or frame-by-frame playback mode,

- the picture will be distorted.
- the noise bars will appear.
- there will be a loss of colour with an LP-recorded tape.

## Variable-Speed Search

### 1 ACTIVATE VARIABLE-SPEED SEARCH

During playback, press **PUSH JOG** ◀ or ▶.

- The more times you press, the faster the playback picture moves.
- To decrease speed, press the button for the opposite direction.

To resume normal playback, press **PLAY**.

## Still Picture/Frame-By-Frame Playback

### 1 PAUSE DURING PLAYBACK

Press **PAUSE**. If there is vertical jitter, use the **TV PROG** buttons to correct the picture.

### 2 ACTIVATE FRAME-BY-FRAME PLAYBACK

Press **PAUSE**.

**OR**

Press **PUSH JOG** ◀ or ▶.

To resume normal playback, press **PLAY**.

## Slow Motion

### 1 ACTIVATE SLOW-MOTION PLAYBACK

During still picture, press and hold **PAUSE** for 2 seconds, then release. Press and release again to return to still picture.

**OR**

During still picture, press and hold **PUSH JOG** ◀ or ▶. Release to return to still picture.

To resume normal playback, press **PLAY**.

## High-Speed Search

### 1 ACTIVATE HIGH-SPEED SEARCH

During playback or still, press **FF** for forward high-speed search, or **REW** for reverse high-speed search.

To resume normal playback, press **PLAY**.

## NOTE:

*For short searches, press and hold **FF** or **REW** for over 2 seconds during playback or still picture. When released, normal playback resumes.*

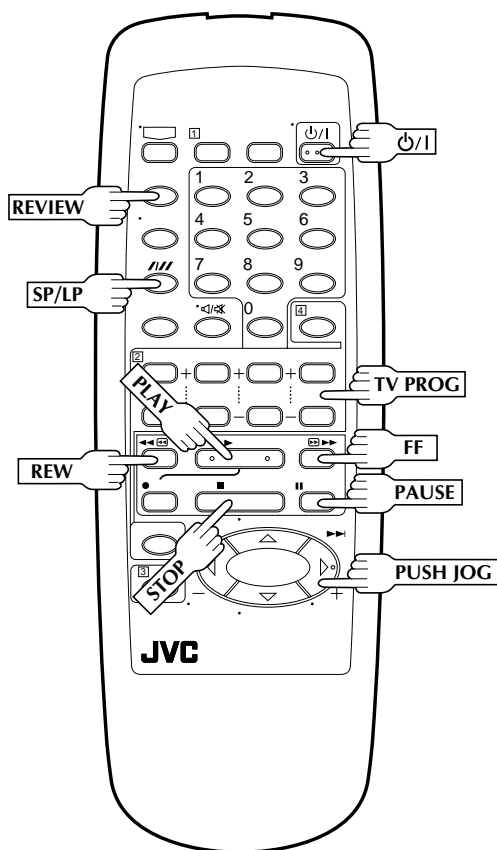

## Manual Tracking

Your video recorder is equipped with automatic tracking control. During playback, you can override this and adjust the tracking manually by pressing the **TV PROG** buttons.

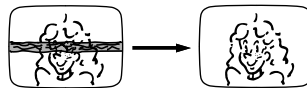

### 1 OVERRIDE AUTOMATIC TRACKING

Press **///** (SP/LP) on the remote to engage manual tracking.

### 2 ADJUST TRACKING MANUALLY

Press **TV PROG +** or **-** to adjust tracking.

### 3 RETURN TO AUTOMATIC TRACKING

Press **///** (SP/LP) on the remote to re-engage automatic tracking.

#### NOTE:

When a new tape is inserted, the recorder enters the automatic tracking mode automatically.

## Repeat Playback

Your video recorder can automatically play back the whole tape 50 times repeatedly.

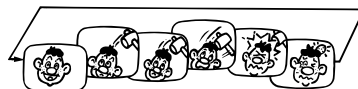

### 1 START PLAYBACK

Press **PLAY**.

### 2 ACTIVATE REPEAT PLAYBACK

Press **PLAY** and hold for over 5 seconds, then release.

- The Play indicator (▶) on the display panel blinks slowly.
- The tape plays 50 times automatically, and then stops.

### 3 STOP PLAYBACK

Press **STOP** at any time to stop playback.

#### NOTE:

Pressing **PLAY**, **REW**, **FF** or **PAUSE** also stops Repeat Playback.

## NTSC Playback

Your video recorder is equipped with NTSC circuitry that can play back NTSC tapes.

### 1 LOAD A CASSETTE

Insert a cassette recorded in NTSC.

### 2 START PLAYBACK

Press **PLAY**.

- Some TVs shrink the picture vertically and place black bars at the top and bottom of the screen. This is not a malfunction on the part of either the video recorder or the TV.
- The picture may roll up and down. This can be corrected using the V-HOLD control found on some TVs. (This cannot be corrected if the TV does not have a V-HOLD control.)
- The counter and tape remaining time readings will be incorrect.
- During search, still, or frame-by-frame playback, the picture will be distorted, and there may be a loss of colour.
- Depending on the type of TV, the top and bottom portions of superimposed displays may be cut off during NTSC playback.

## Index Search

Your recorder automatically marks index codes at the beginning of each recording. This function gives you quick access to any one of 9 index codes in either direction.

### NOTE:

Before starting, make sure the recorder is in the Stop mode.



## 1 ACTIVATE INDEX SEARCH

Press **PUSH JOG** < or > on the remote control. "◀◀ 1" or "▶▶ 1" is displayed on screen and search begins in the corresponding direction.

- To access index codes 2 through 9, press **PUSH JOG** < or > repeatedly until the correct index number is displayed.

Ex.: To locate the beginning of B from the current position, press **PUSH JOG** < twice.  
To locate the beginning of D from the current position, press **PUSH JOG** > once.

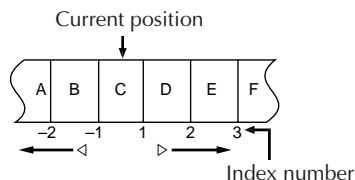

- When the specified index code is located, playback begins automatically.

## Next Function Memory

You can set your recorder's power to go off automatically after the tape is fully rewound. Before starting, make sure the recorder is in the Stop mode.

For Automatic Power Off After Tape Rewind . . .  
. . . press **REW**, then press **⏻** within 2 seconds.

## Tape Position Indicator

The tape position indicator appears on screen when, from the Stop mode, you press **FF**, **REW** or perform an Index Search. The position of "■" in relation to "0" (beginning) or "+" (end) shows you where you are on the tape. "O.S.D." (ⓘ pg. 9) must be set to "ON", or the indicator will not appear.

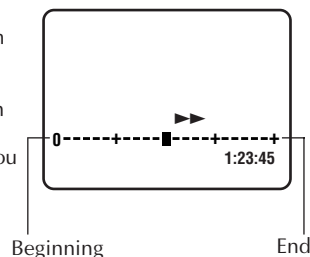

### NOTE:

Depending on the type of tape used, there may be times when the indication is not correct.

## Instant ReView

Simply by pressing a single button, the recorder power comes on, rewinds, and begins playback of the last timer-recorded programme. If you have several programmes recorded, you can easily access any of them.

### NOTE:

Before starting, make sure that the recorder is off and that the Timer mode is disengaged.

## 1 ACTIVATE INSTANT REVIEW

Press **REVIEW**. The recorder power comes on and the recorder searches for the index code indicating the start of the last timer-recorded programme. Once it's found, playback begins automatically.

- The front display panel tells you how many programmes have been recorded. If you have, for example, 3 programmes, "REVIEW" and "3" appear and blink. To watch the first of the 3 programmes, press **REVIEW** three times. The recorder searches and begins playback automatically. You can access a programme as far as 9 index codes away from the current tape position.

### NOTE:

Instant ReView is not possible while the recorder is in the Timer mode.

# Basic Recording

Turn on the TV and select the VIDEO channel (or AV mode).

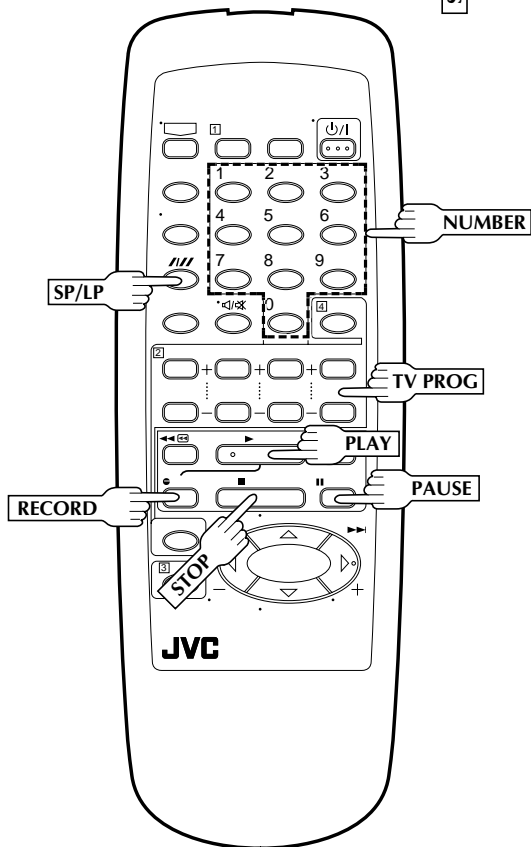
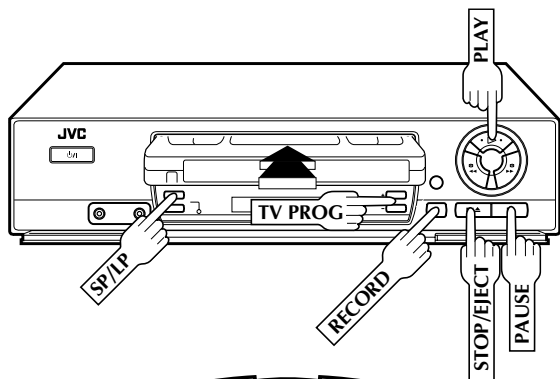

TV signals being received by the recorder's built-in tuner can be recorded onto a video tape. You can "capture" a TV programme using your video recorder.

1

## LOAD A CASSETTE

Insert a cassette with the record safety tab intact.

- The counter is reset to 0:00:00 and the recorder power comes on automatically.

2

## CHOOSE A PROGRAMME

Press **TV PROG +/-** or the **NUMBER** keys to select the channel you wish to record.

3

## SET TAPE SPEED

Press **SP/LP (//)**. Check the SP/LP indicator on the recorder display panel to confirm the selected tape speed.

4

## START RECORDING

Press and hold **RECORD** and **PLAY** on the remote control, or press **RECORD** on the recorder.

B.E.S.T. takes place at the beginning of both the first SP and the first LP recording after inserting the cassette (see pg. 16).

5

## PAUSE/RESUME RECORDING

Press **PAUSE**. Press **PLAY** to resume recording.

6

## STOP RECORDING

Press **STOP** on the remote control or **STOP/EJECT** on the recorder. Then press **STOP/EJECT** to remove the cassette.

## Recording Resume Function

If there is a power outage during recording (or Instant Timer Recording or timer recording), the recording will resume automatically when power is restored to the recorder unless the recorder's memory backup has expired.

### Accidental erasure prevention

- To prevent accidental recording on a recorded cassette, remove its safety tab. To record on it later, cover the hole with adhesive tape.

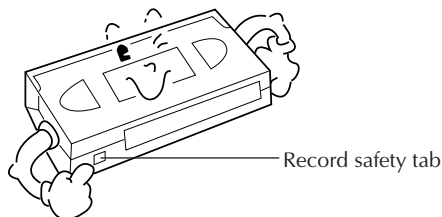

# Recording Features

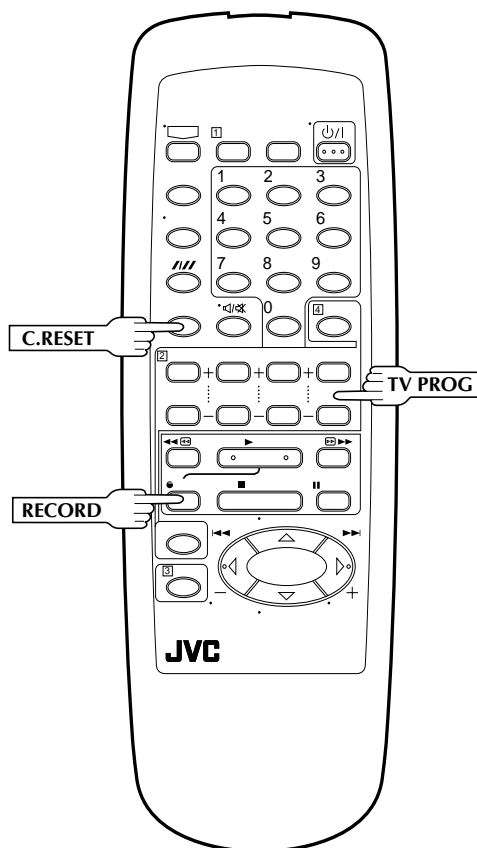
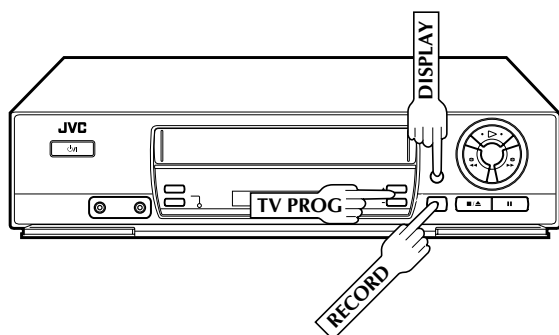

## Record One Programme While Watching Another

### 1 SELECT CHANNEL TO WATCH

Once recording is in progress, all you need to do is to set the channel controls on the TV for the station you wish to view.

- The programme selected with the TV's channel controls appears on the TV screen while the one selected with the **TV PROG** buttons is recorded on the tape.

## Elapsed Recording Time Indication

You can check the exact time of a recording.

### 1 SET COUNTER DISPLAY

Press **DISPLAY** until a counter reading appears on the display panel.

### 2 RESET COUNTER

Press **C. RESET** before starting recording or playback.

- The counter is reset to "0:00:00" and shows the exact elapsed time as the tape runs.

## Instant Timer Recording (ITR)

This easy method lets you record for from 30 minutes to 6 hours (selectable in 30-min. increments), and shuts the recorder off after recording is finished.

### 1 START RECORDING

Press **RECORD** on the recorder.

### 2 ENGAGE ITR MODE

Press **RECORD** again. "0" blinks and 0:30 appears on the front display panel.

### 3 SET RECORDING DURATION

If you want to record for more than 30 minutes, press **RECORD** to extend the time. Each press extends recording time by 30 minutes.

## NOTE:

You can only perform ITR using the **RECORD** button on the recorder's front panel.

# B.E.S.T. Picture System

Turn on the TV and select the VIDEO channel (or AV mode).

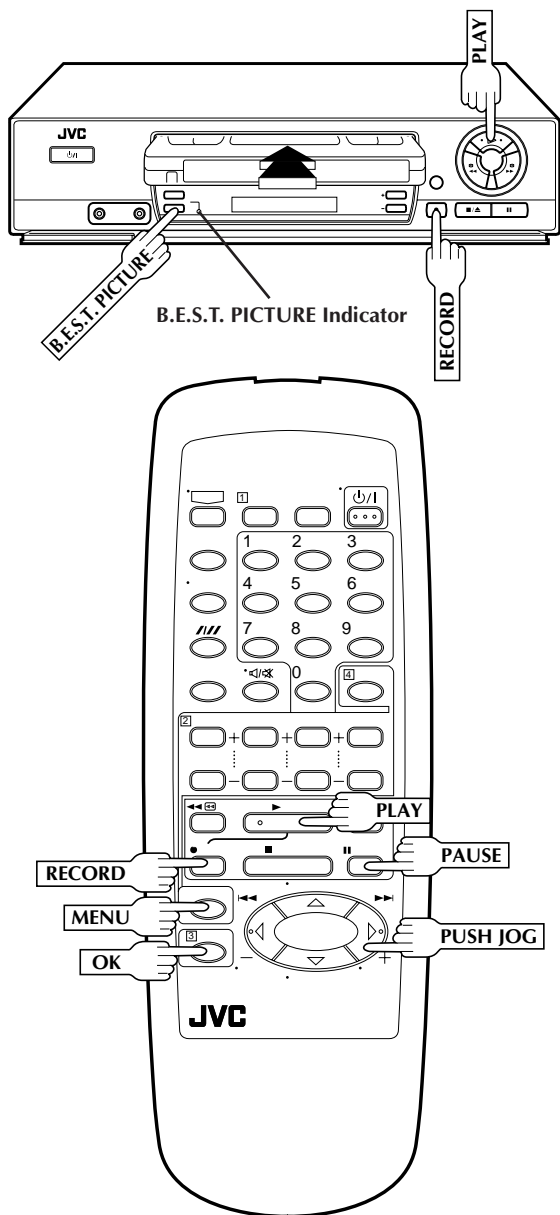

The B.E.S.T. (Biconditional Equalised Signal Tracking) system checks the condition of the tape in use during recording and playback, and compensates to provide the highest-possible recording and playback pictures. The default setting for both recording and playback is "ON".

## Preparation

### 1 LOAD A CASSETTE

Insert a cassette with the record safety tab intact.

- The recorder power comes on automatically.

### 2 ACCESS MAIN MENU SCREEN

Press **MENU**.

### 3 ACCESS FUNCTION SET SCREEN

Place the pointer next to "FUNCTION SET" by pressing **PUSH JOG**  $\Delta$  $\nabla$ , then press **OK** or **PUSH JOG**  $\triangleright$ .

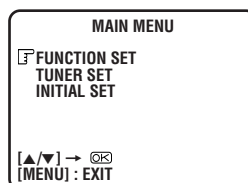

### 4 SELECT MODE

Place the pointer next to "B.E.S.T." by pressing **PUSH JOG**  $\Delta$  $\nabla$ , then press **OK** or **PUSH JOG**  $\triangleright$  to set to "ON" or "OFF".

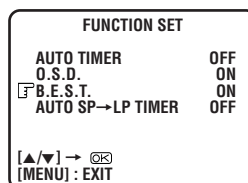

### 5 RETURN TO NORMAL SCREEN

Press **MENU**.

You can also turn on/off the B.E.S.T. system by simply pressing the **B.E.S.T. PICTURE** button on the recorder.

- 1 Press **B.E.S.T. PICTURE** so that the B.E.S.T. PICTURE indicator lights up.
  - The B.E.S.T. system is activated and the "B.E.S.T." setting at the Function Set screen will also be set to "ON".
- 2 To turn off the B.E.S.T. system, press the **B.E.S.T. PICTURE** button again so that the B.E.S.T. PICTURE indicator goes off.
  - The "B.E.S.T." setting at the Function Set screen will also be set to "OFF".



## Recording

### START RECORDING

**1** Press and hold **RECORD** and press **PLAY** on the remote, or press **RECORD** on the recorder.

**DURING B.E.S.T.**

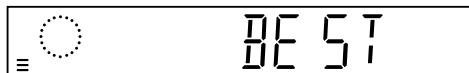

**B.E.S.T. COMPLETE**

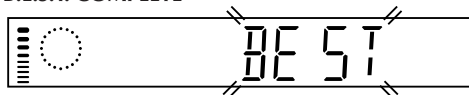

- The recorder spends approximately 7 seconds assessing the condition of the tape, then begins recording.

### NOTES:

- The B.E.S.T. system works for both SP and LP modes only after a tape has been inserted and the Record mode is first initiated. It does not work during recording.
- In the case of timer recording, the B.E.S.T. system works before recording is initiated.
- Once the cassette is ejected, the B.E.S.T. data is cancelled. The next time the cassette is used for recording, B.E.S.T. is re-performed.
- Pressing the recorder's **RECORD** button while "BEST" is displayed does not start Instant Timer Recording (⌚ pg. 15).

### ATTENTION

*Since the B.E.S.T. system works before recording actually starts, there is a delay of approximately 7 seconds after **RECORD** and **PLAY** on the remote are pressed, or **RECORD** on the recorder is pressed. To make sure you record the desired scene or programme in its entirety, first perform the following steps:*

- 1) Press and hold **PAUSE** and press **RECORD** to engage the **RECORD PAUSE** mode.
  - The recorder then automatically checks the condition of the tape and, after approximately 7 seconds, re-enters **RECORD PAUSE**.
- 2) Press **PLAY** to start recording.
  - If you want to bypass the B.E.S.T. system and begin recording immediately, set "B.E.S.T." to "OFF" in step 4 on page 16.

## Playback

The recorder assesses the quality of the tape once you initiate playback.

### START PLAYBACK

**1** Press **PLAY**.

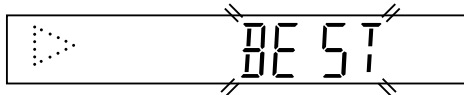

- The recorder adjusts the playback picture quality based on the quality of the tape in use.
- B.E.S.T. is active during Auto Tracking. "BEST" appears blinking on the recorder's display panel.

### NOTES:

- When watching a tape recorded with "B.E.S.T." set to "ON", it is recommended that you leave B.E.S.T. on during playback as well.
- When watching a rental tape or one recorded on another video recorder, or when using this recorder as the player for editing, set B.E.S.T. to your preference by performing steps 1 through 5 on page 16.
- "BEST" only appears at the beginning of automatic tracking. Even though it doesn't appear after that, the B.E.S.T. function is operative.

# G-CODE Setup

Turn on the TV and select the VIDEO channel (or AV mode).

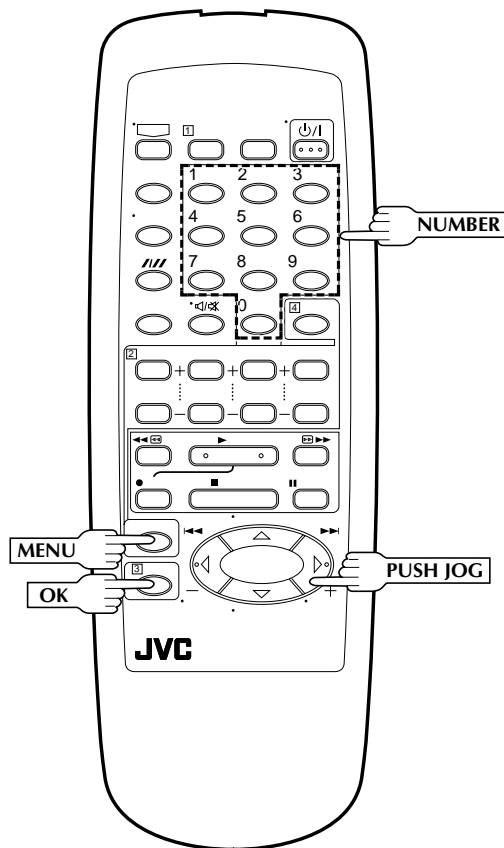

The G-CODE timer programming system eliminates the need to input channel, date, start and stop time data when setting the timer record function. Simply key in the G-CODE number for the TV programme you wish to record (found in most TV listings) and the recorder's timer is automatically programmed.

You have to set "GUIDE PROG" numbers, which are assigned to each station for purposes of G-CODE timer programming, for all the stations stored in your recorder's memory to get proper results.

Before G-CODE setup you must have performed the following procedures:

- Tuner setting (☞ pg. 6, 28)
- Clock setting (☞ pg. 8)

## IMPORTANT

Perform the following procedure after Auto Set Up on page 6 and/or the channel setting steps on pages 28 – 31. After setting the Guide Program Numbers, channel positions may be incorrect if you stored or skipped channels. In this case, re-perform Guide Program Number setting.

## Guide Program Number Set

### 1 ACCESS MAIN MENU SCREEN

Press **MENU**.

### 2 ACCESS INITIAL SET SCREEN

Press **PUSH JOG**  $\Delta$ / $\nabla$  to place the pointer next to "INITIAL SET", then press **OK** or **PUSH JOG**  $\triangleright$ .

### 3 ACCESS G-CODE SET-UP

Press **PUSH JOG**  $\Delta$ / $\nabla$  to place the pointer next to "G-CODE SET-UP", then press **OK** or **PUSH JOG**  $\triangleright$ .

### 4 ENTER GUIDE PROG NUMBER

Press **PUSH JOG**  $\Delta$ / $\nabla$  or **NUMBER** keys to enter the Guide Program number for the desired station as shown in the TV listings. Then press **OK** or **PUSH JOG**  $\triangleright$ .

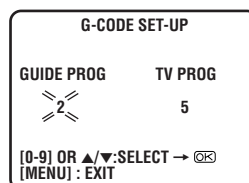

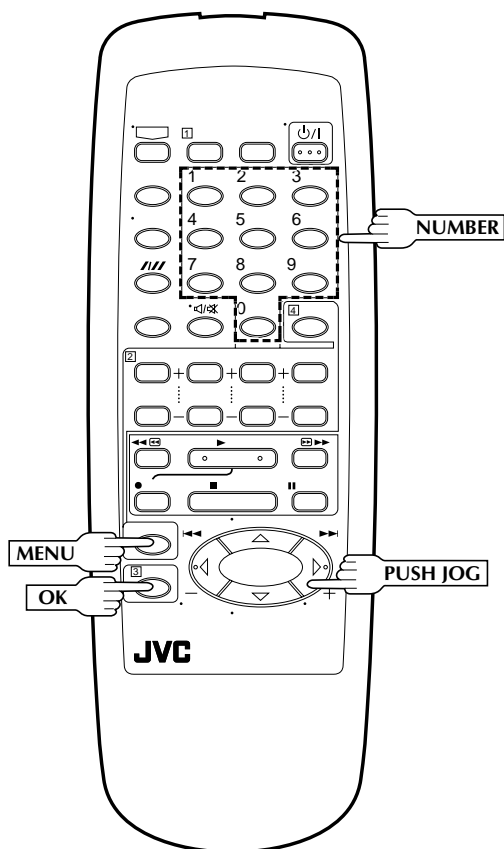

5

## ENTER RECEIVING CHANNEL POSITION NUMBER

Press **PUSH JOG**  $\Delta \nabla$  or **NUMBER** keys to input the number of the recorder's channel position on which the Guide Program number's broadcast is received. Then press **OK** or **PUSH JOG**  $\triangleright$ .

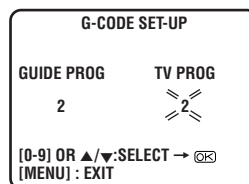

- If the satellite broadcast is received on your recorder's auxiliary channel "F-1", select "F-1" for the channel position.
- Repeat steps 4 and 5 as necessary.

6

## RETURN TO NORMAL SCREEN

Press **MENU**.

### Guide Program Number

"Guide Program (GUIDE PROG) number" refers to the assigned TV station numbers, according to broadcast area, for G-CODE timer recording. The Guide Program numbers can be found in most TV listings.

# G-CODE Timer Programming

## Before performing G-CODE Timer Programming:

- Be sure to read "G-CODE Setup" (pg. 18).
- Insert a cassette with the safety tab in place. The recorder will come on automatically.
- Turn on the TV and select the VIDEO channel (or AV mode).

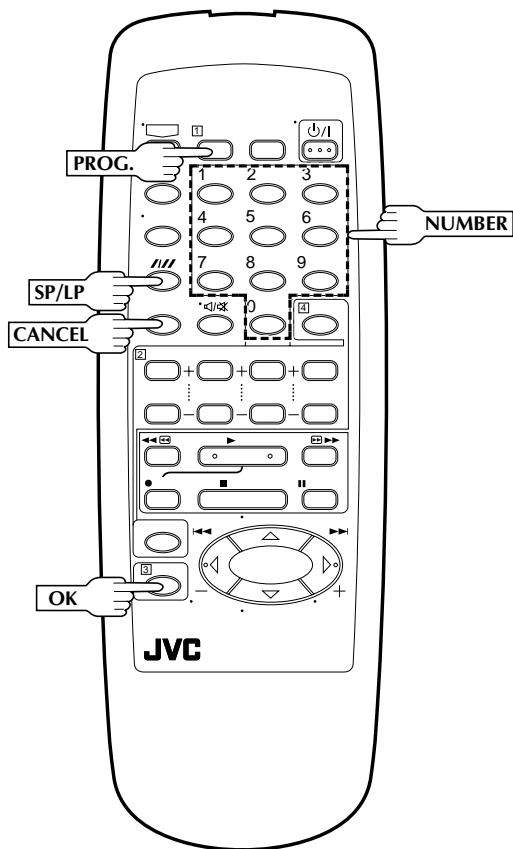

1

## ACCESS G-CODE SCREEN

Press **PROG.**

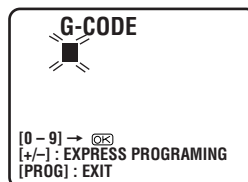

2

## ENTER G-CODE NUMBER

Press the **NUMBER** keys to enter the G-CODE number of a programme you wish to record.

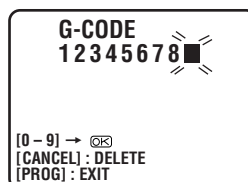

- If you make a mistake, press **CANCEL** and input the correct number.

3

## ACCESS G-CODE PROGRAM SCREEN

Press **OK**, and the G-CODE Program screen appears (if you're just starting out, "P1" appears).

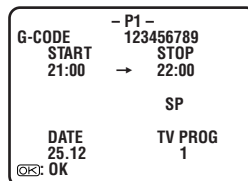

## IMPORTANT

Make sure the channel position number you wish to record is displayed; if not, see "G-CODE Setup" on page 18 and set the Guide Program number for that G-CODE number correctly.

- If the number you entered is invalid, "ERROR" appears on the screen and "Err" appears on the display panel. Press **CANCEL** and input a valid G-CODE number.
- If the "GUIDE PROG SET" screen appears, see "ATTENTION – Regarding Guide Program Number Set" on page 21.

4

## SET TAPE SPEED

Press **SP/LP** (//) to set the tape speed.

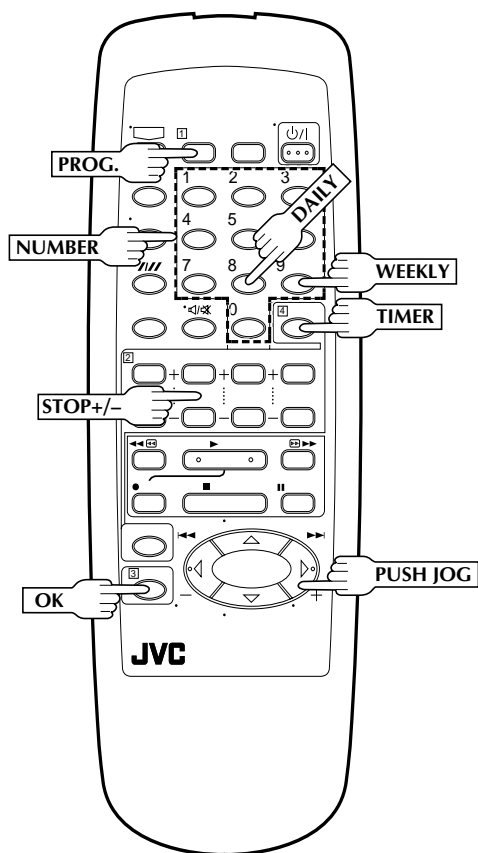

## 5 RETURN TO NORMAL SCREEN

Press **PROG.** or **OK**. "PROGRAM COMPLETED" appears on the screen for about 5 seconds, then normal screen appears.

- Repeat steps 1 – 5 for each additional programme.

## 6 ENGAGE RECORDER'S TIMER MODE

Press **TIMER**. The recorder turns off automatically and  appears on the display panel.

- To disengage the timer, press **TIMER** again.

### NOTES:

- *To Change The Stop Time . . .*  
 . . . press **STOP +/-** after pressing **OK** in step 3. You can compensate for anticipated programme schedule delays this way.
- *To Timer-Record Weekly Or Daily Serials . . .*  
 . . . after pressing **OK** in step 3, press **WEEKLY** (**NUMBER** key "9") for weekly serials or **DAILY** (**NUMBER** key "8") for daily serials (Monday – Friday). Either "WEEKLY" or "DAILY" appears on the screen. Pressing the button again makes the corresponding indication disappear.
- You can programme this recorder to timer-record as many as 8 programmes. If you try to programme the recorder to record a ninth, "PROGRAM FULL" appears on screen and "FULL" appears on the front display panel. To record the extra programme, you must first cancel any unnecessary programmes (see pg. 24).
- It is not possible to timer-record a TV programme with a G-CODE number which starts with "0".

#### Satellite Tuner Users

To timer-record a satellite broadcast using G-CODE:

- 1 Perform steps 1 – 6.
- 2 Set the satellite tuner to the appropriate channel before the selected programme begins.
- 3 Leave the satellite tuner's power on.

### ATTENTION

#### Regarding Guide Program Number Set

"GUIDE PROG SET" appears after performing step 3 if the Guide Program number for the G-CODE number you entered has not been set.

- Press the **NUMBER** keys or **PUSH JOG**  $\Delta \nabla$  to input the channel position number on which your recorder receives that station, then press **OK** or **PUSH JOG**  $\triangleright$ . The G-CODE program screen appears.

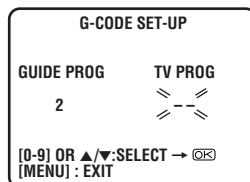

(Ex.) To timer-record a RTR programme with G-CODE.  
 \* If your recorder receives RTR on the channel position 2, press **OK** or **PUSH JOG**  $\triangleright$  after entering "2".

# Express Timer Programming

Remember, the clock must be set before you can programme the timer (☞ pg. 8).

Before performing the following steps:

- Insert a cassette with the safety tab in place. The recorder will come on automatically.
- Turn on the TV and select the VIDEO channel (or AV mode).

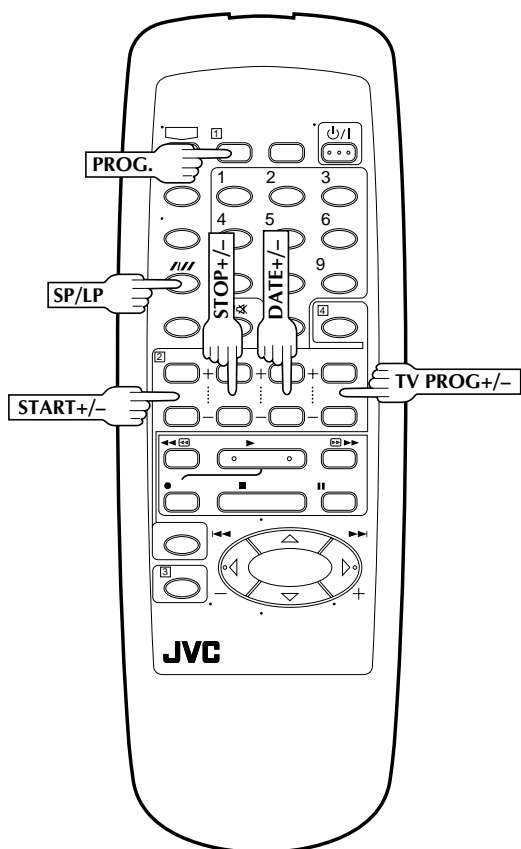

1

## ACCESS G-CODE SCREEN

Press **PROG.**.

2

## ACCESS PROGRAMME SCREEN

Press **START +/-**. (If you're just starting out, "P1" appears.)

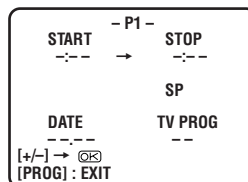

3

## ENTER PROGRAMME START TIME

Press **START +/-** to enter the time you want recording to start.

- Press and hold **START +/-** to move in 30-minute increments, or press and release repeatedly to move 1 minute at a time.

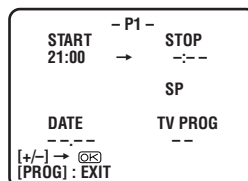

4

## ENTER PROGRAMME STOP TIME

Press **STOP +/-** to enter the time you want recording to stop.

- Press and hold **STOP +/-** to move in 30-minute increments, or press and release repeatedly to move 1 minute at a time.

5

## ENTER PROGRAMME DATE

Press **DATE +/-**. (The current date appears on screen. The date you enter appears in its place.)

6

## ENTER CHANNEL POSITION

Press **TV PROG +/-**.

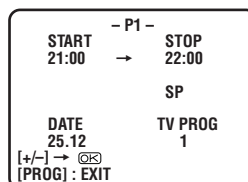

7

## SET TAPE SPEED

Press **SP/LP (///)** to set the tape speed.

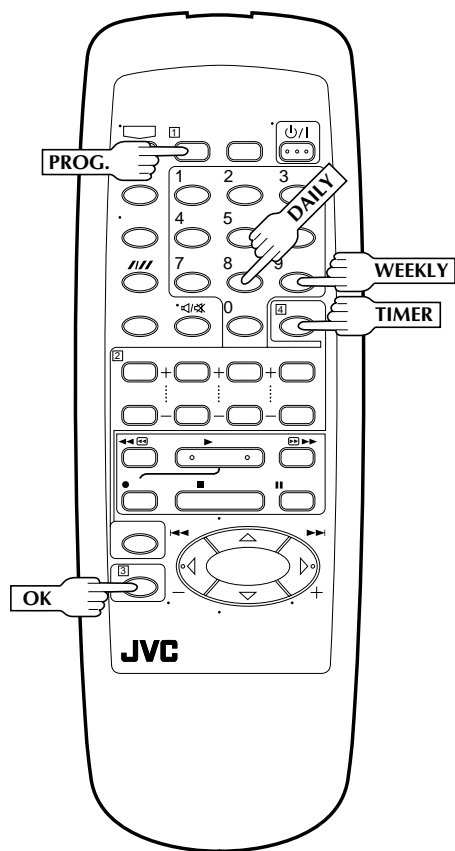

## RETURN TO NORMAL SCREEN

# 8

After confirming all information is correct, press **PROG.** or **OK**. "PROGRAM COMPLETED" appears on the screen for about 5 seconds, then normal screen appears.

- Repeat steps 1-8 for each additional programme.

## ENGAGE RECORDER'S TIMER MODE

# 9

Press **TIMER**. The recorder turns off automatically and  appears on the display panel.

- To disengage the timer, press **TIMER** again.

*To Timer-Record Weekly Or Daily Serials . . .*

. . . anytime during steps 2 through 8, press **WEEKLY** (NUMBER key "9") for weekly serials or **DAILY** (NUMBER key "8") for daily serials (Monday-Friday). Either "WEEKLY" or "DAILY" appears on the screen. Pressing the button again makes the corresponding indication disappear.

### NOTE:

*You can programme this recorder to timer-record as many as 8 programmes. If you try to programme the recorder to record a ninth, "PROGRAM FULL" appears on screen. To record the extra programme, you must first cancel any unnecessary programmes ( pg. 24).*

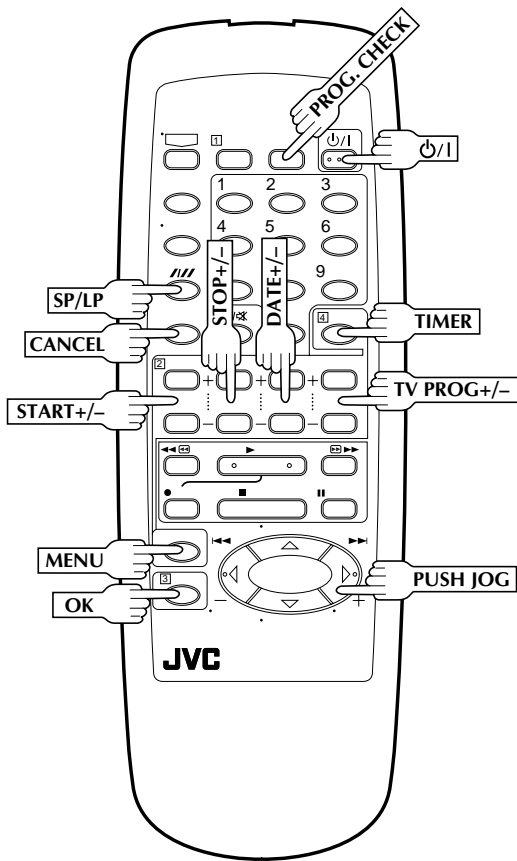

## Check, Cancel And Replace Programmes

### 1 DISENGAGE TIMER MODE

Press **TIMER**, then press **P/I**.

### 2 ACCESS PROGRAMME CHECK SCREEN

Press **PROG. CHECK**.

PR	START	STOP	CH	DATE
1	8:00	10:00	3	24.12
2	10:00	10:45	2	25.12
3	11:30	13:00	1	25.12
4				
5				
6				
7				
8				

[PROG CHECK] : NEXT

### 3 ACCESS PROGRAMME SCREEN

Press **PROG. CHECK** again to check more information. Each time you press **PROG. CHECK**, the next programme's information appears.

- P1 -	
START 8:00	STOP 10:00
SP	
DATE 24:12	TV PROG 3

[PROG CHECK] : EXIT

## To cancel or replace a programme...

### 4 CANCEL OR REPLACE A PROGRAMME

Press **CANCEL** to cancel a programme. To replace a programme, press the appropriate button: **START+/-**, **STOP+/-**, **DATE+/-**, **TV PROG+/-**, **SP/LP** (///).

### 5 RETURN TO NORMAL SCREEN

Press **PROG. CHECK** as many times as necessary. If there are still some programmes remaining, go on to step 6.

### 6 RETURN TO TIMER MODE

Press **TIMER**.



## Auto SP→LP Timer

If, when timer-recording in SP mode, there is not enough tape to record the entire programme, the recorder automatically switches to LP mode to allow complete recording.

### For Example . . .

Recording a PAL-broadcast programme of 210 minutes in length onto a 180-minute tape

Approximately 150 minutes      Approximately 60 minutes

SP mode	LP mode
---------	---------

Total 210 minutes

Make sure you set "AUTO SP→LP TIMER" to "ON" at the Mode Set screen before the timer-recording starts.

### 1 ACCESS MAIN MENU SCREEN

Press **MENU**.

### 2 ACCESS FUNCTION SET SCREEN

Press **PUSH JOG**  $\Delta \nabla$  to place the pointer next to "FUNCTION SET", then press **OK** or **PUSH JOG**  $\triangleright$ .

### 3 SELECT MODE

Press **PUSH JOG**  $\Delta \nabla$  to place the pointer next to "AUTO SP→LP TIMER", then press **OK** or **PUSH JOG**  $\triangleright$  to select "ON".

FUNCTION SET	
AUTO TIMER	OFF
O.S.D.	ON
B.E.S.T.	ON
<input checked="" type="checkbox"/> AUTO SP→LP TIMER	ON

[▲/▼] → [MENU]: EXIT

### 4 RETURN TO NORMAL SCREEN

Press **MENU**.

## Auto Timer

When the Auto Timer is set to ON the timer is automatically engaged when the recorder power is turned off and automatically disengaged when the recorder is powered back on.

### 1 ACCESS MAIN MENU SCREEN

Press **MENU**.

### 2 ACCESS FUNCTION SET SCREEN

Press **PUSH JOG**  $\Delta \nabla$  to place the pointer next to "FUNCTION SET", then press **OK** or **PUSH JOG**  $\triangleright$ .

MAIN MENU	
<input checked="" type="checkbox"/> FUNCTION SET	
TUNER SET	
INITIAL SET	

[▲/▼] → [MENU]: EXIT

### 3 SELECT MODE

Press **OK** or **PUSH JOG**  $\triangleright$  to select either "ON" or "OFF".

FUNCTION SET	
<input checked="" type="checkbox"/> AUTO TIMER	OFF
O.S.D.	ON
B.E.S.T.	ON
AUTO SP→LP TIMER	OFF

[▲/▼] → [MENU]: EXIT

### 4 RETURN TO NORMAL SCREEN

Press **MENU**.

### NOTE:

For safety, when Auto timer is set to "OFF", all other recorder functions are disabled while the Timer mode is engaged. To disengage the timer, press **TIMER**.

### NOTES:

- If you have programmed the recorder to timer-record 2 or more programmes, the second programme and those thereafter may not fit on the tape if you set "AUTO SP→LP TIMER" to "ON". In this case, make sure the mode is not engaged, then set the tape speed manually during timer programming.
- In order to ensure that the recording fits on the tape, this feature may leave a slight non-recorded section at the end of the tape.
- There may be some noise and sound disturbance at the point on the tape where the recorder switches from SP to LP mode.
- The Auto SP→LP Timer feature is not available during ITR (Instant Timer Recording), and the feature will not work properly with any tapes longer than E-180 or with some tapes of shorter lengths.

# Edit To Another Video Recorder

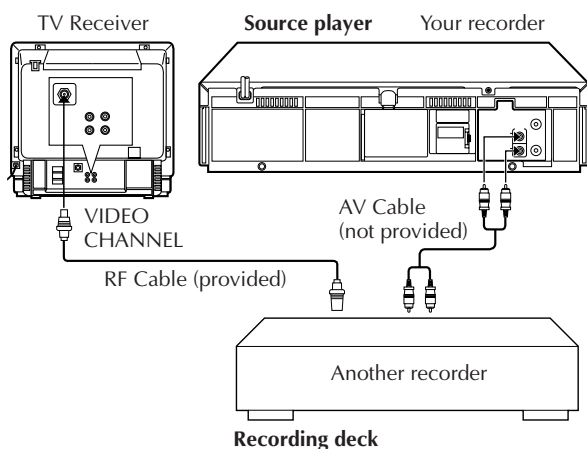

You can use your video recorder as the source player and another video recorder as the recording deck.

1

## MAKE CONNECTIONS

Connect the player's AUDIO/VIDEO OUT connectors to the recorder's AUDIO/VIDEO IN connectors.

2

## SET RECORDING DECK'S INPUT MODE

Set the recording deck's external input mode.

3

## START SOURCE PLAYER

Press **PLAY** on the source player.

4

## START RECORDING DECK

Engage its Record mode.

### NOTES:

- All necessary cables can be obtained from your dealer.
- If you do not want to record the superimposed indication on the edited tape, be sure to set "O.S.D." to "OFF" before you start editing (☞ pg. 9).

# Edit From A Camcorder Or Another Video Recorder

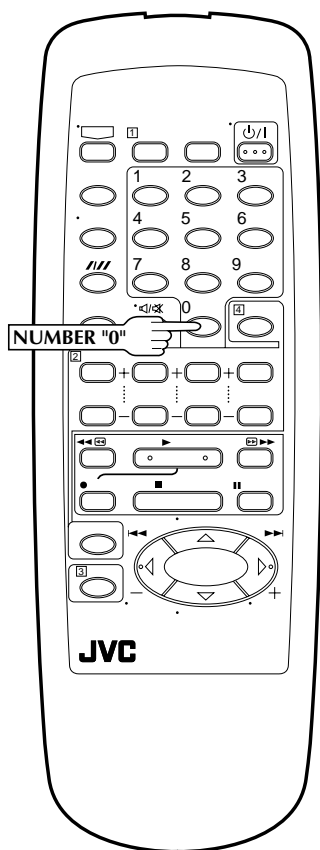

You can use a camcorder or another video recorder as the source player and your video recorder as the recording deck.

- 1** **MAKE CONNECTIONS**  
Connect the AUDIO/VIDEO OUT connectors on the camcorder or another video recorder to the front panel AUDIO/VIDEO input connectors on the recording deck.
- 2** **SET RECORDER'S INPUT MODE**  
Press **NUMBER** key "0" so that "F-1" appears on the display panel.
- 3** **START SOURCE PLAYER**  
Engage its Play mode.
- 4** **START RECORDING DECK**  
Engage its Record mode.

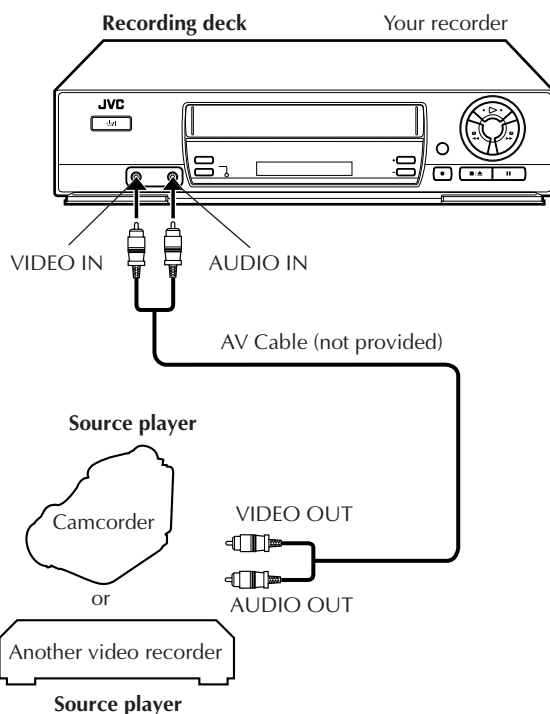

Turn on the TV and select the VIDEO channel (or AV mode).

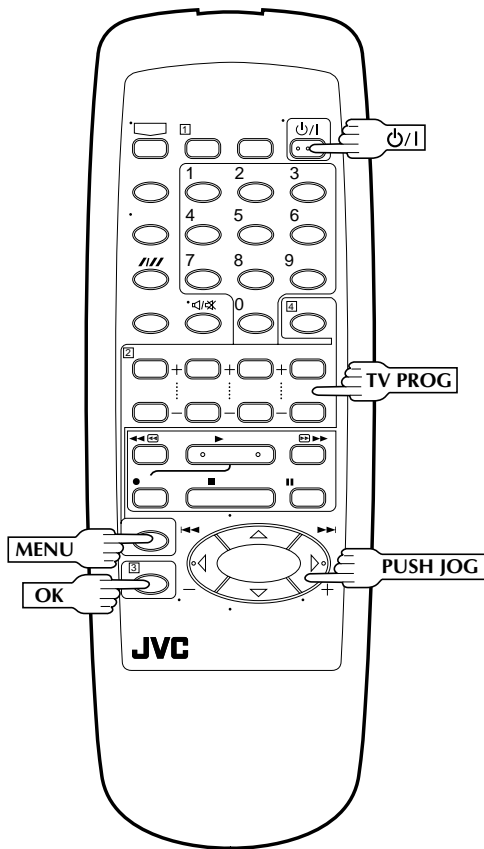

**IMPORTANT**

Perform the following steps only if auto channel set has not been set correctly by Auto Set Up function (pg. 6) or if you have moved to a different area or if a new station starts broadcasting in your area.

Your recorder needs to memorise all necessary stations in channel positions in order to record TV programmes. Auto Channel Set automatically assigns all receivable stations in your area so that you can call them up with the **TV PROG** buttons without going through any vacant channels.

**Auto Channel Set**

**1 TURN ON THE RECORDER**

Press ⏻/I.

**2 ACCESS MAIN MENU SCREEN**

Press MENU.

**3 ACCESS TUNER SET SCREEN**

Press **PUSH JOG** Δ∇ to place the pointer next to "TUNER SET", then press **OK** or **PUSH JOG** ▷.

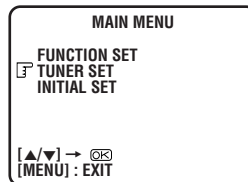

**4 SELECT AUTO CH SET MODE**

Press **PUSH JOG** Δ∇ to place the pointer next to "AUTO CH SET", then press **OK** or **PUSH JOG** ▷.

- Auto Channel Set will start.

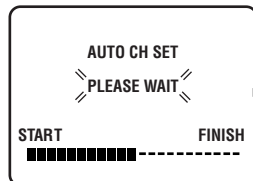
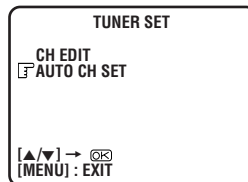

CH	FRQ	CH	FRQ
01	150	07	229
02	165	08	237
03	195	09	355
04	205	10	365
05	213	11	374
06	221	12	384

[▲/▼] → [CANCEL] : DELETE  
[▲/▼] → [OK] : EDIT  
[MENU] : EXIT

**5 RETURN TO NORMAL SCREEN**

Press MENU.

**IMPORTANT**

Since your video recorder memorizes all detected stations even if the reception condition is poor, some of those stored stations may produce a noisy picture. To delete those stations, use "Delete A Channel" on page 30.

## Manual Channel Set

Store channels that were not stored during Auto Set Up (☞ pg. 6) or Auto Channel Set (☞ pg. 28).

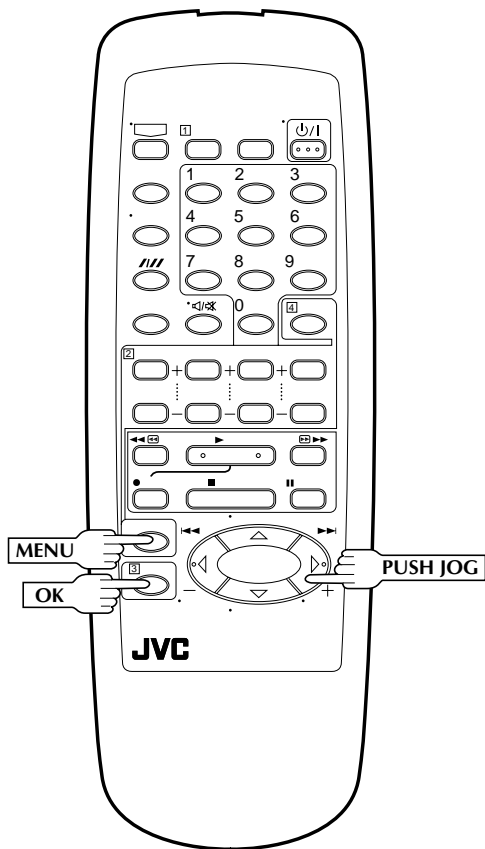

### 1 ACCESS TUNER SET SCREEN

Perform steps 1 – 3 of "Auto Channel Set" on page 28.

### 2 ACCESS CHANNEL LIST

Press **PUSH JOG**  $\Delta \nabla$  to place the pointer next to "CH EDIT", then press **OK** or **PUSH JOG**  $\triangleright$ .

### 3 SELECT POSITION

Press **PUSH JOG**  $\Delta \nabla$  to place the pointer next to an open channel position, then press **OK** or **PUSH JOG**  $\triangleright$ .

### 4 SELECT BAND

Press **PUSH JOG**  $\Delta \nabla$  to place the pointer next to the band of your choice, then press **OK** to initiate Manual Channel Set.

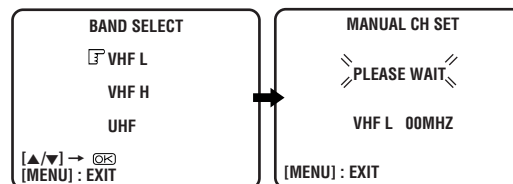

### 5 SET DESIRED STATION

The screen to the right appears when a station is detected.

*If you do not want to store the detected station...*

Press **PUSH JOG**  $\Delta \nabla$  to place the pointer next to "CONTINUE", then press **OK** or **PUSH JOG**  $\triangleright$ .

Channel search will resume.

*If you want to store the detected station...*

Press **PUSH JOG**  $\Delta \nabla$  to place the pointer next to "STORE", then press **OK** or **PUSH JOG**  $\triangleright$ . The Channel List appears again.

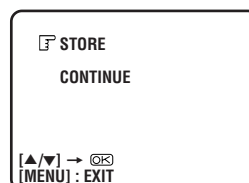

- The blueback screen and the TV picture currently being broadcast appear alternately for 8 seconds each.
- If you want to store another channel, repeat steps 3 – 5.
- When channel search completes for that band, the Band Select screen appears again. To set channels for other bands, select another band and start Manual Channel Set again (☞ step 4 and 5).
- For fine tuning adjustment, see "Fine-Tuning Channels" on page 31.

### 6 RETURN TO NORMAL SCREEN

Press **MENU**.

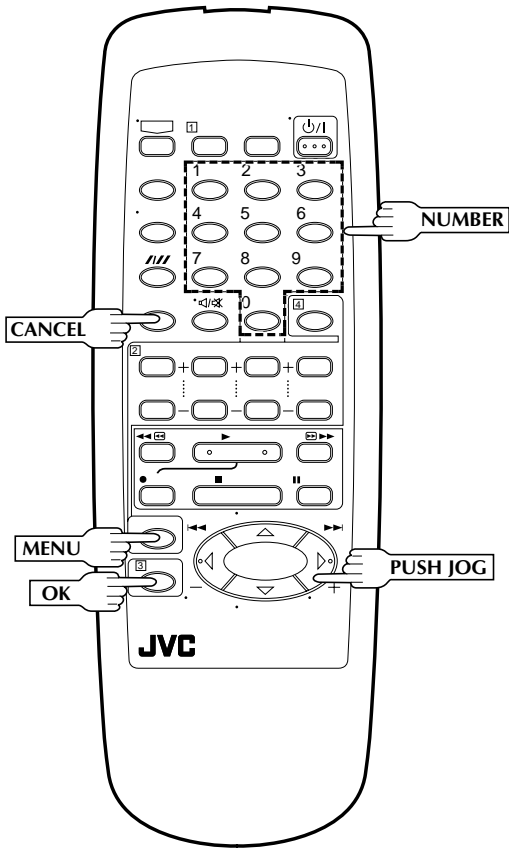

## Delete A Channel

### 1 ACCESS TUNER SET SCREEN

Perform steps 1 – 3 of "Auto Channel Set" on page 28.

### 2 ACCESS CHANNEL LIST

Press **PUSH JOG**  $\Delta/\nabla$  to place the pointer next to "CH EDIT", then press **OK** or **PUSH JOG**  $\triangleright$ .

### 3 SELECT CHANNEL

Press **PUSH JOG**  $\Delta/\nabla$  to until the channel you want to delete begins blinking.

CH	FREQ	CH	FREQ
01	150	07	229
02	165	08	237
03	195	09	355
04	205	10	365
05	213	11	374
06	221	12	384

[ $\Delta/\nabla$ ]  $\rightarrow$  [CANCEL]: DELETE  
 [ $\Delta/\nabla$ ]  $\rightarrow$  [EDIT]: EDIT  
 [MENU]: EXIT

### 4 DELETE CHANNEL

Press **CANCEL**.

- To re-store it, simply press  $\triangleleft$ .
- Repeat steps 3 – 4 as necessary.

CH	FREQ	CH	FREQ
01	--	07	229
02	165	08	237
03	195	09	355
04	205	10	365
05	213	11	374
06	221	12	384

[ $\Delta/\nabla$ ]  $\rightarrow$  [ $\triangleleft$ ]: ADD  
 [MENU]: EXIT

### 5 RETURN TO NORMAL SCREEN

Press **MENU**.

## Swap Channel Positions

**Example:** To swap CH03 and CH09.

### 1 ACCESS TUNER SET SCREEN

Perform steps 1 – 3 of "Auto Channel Set" on page 28.

### 2 ACCESS CHANNEL LIST

Press **PUSH JOG**  $\Delta$ / $\nabla$  to place the pointer next to "CH EDIT", then press **OK** or **PUSH JOG**  $\triangleright$ .

### 3 SELECT POSITION (e.g. 03)

Press **PUSH JOG**  $\Delta$ / $\nabla$  until the section of CH "03" begins blinking, then press **OK** or **PUSH JOG**  $\triangleright$ .

- Only "03" will blink.

CH	FRQ	CH	FRQ
01	150	07	229
02	165	08	237
03	195	09	355
04	205	10	365
05	213	11	374
06	221	12	384

[0 - 9]: INPUT CH  
 [OK]: FINE TUNING  
 [MENU]: EXIT

### 4 SELECT POSITION (e.g. 09)

Press **NUMBER** keys to input "0" and "9".

- The two selected channels will be swapped.
- To cancel the channel swapping, press **PUSH JOG**  $\triangleleft$ .

CH	FRQ	CH	FRQ
01	150	07	229
02	165	08	237
03	355	09	195
04	205	10	365
05	213	11	374
06	221	12	384

[ $\triangleleft$ ]: CANCEL  
 [OK]: OK  
 [MENU]: EXIT

### 5 STORE NEW POSITIONS

Press **OK** or **PUSH JOG**  $\triangleright$ .

- Repeat steps 3 – 5 as necessary.

### 6 RETURN TO NORMAL SCREEN

Press **MENU**.

## Fine-Tuning Channels

### 1 ACCESS TUNER SET SCREEN

Perform steps 1 – 3 of "Auto Channel Set" on page 28.

### 2 ACCESS CHANNEL LIST

Press **PUSH JOG**  $\Delta$ / $\nabla$  to place the pointer next to "CH EDIT", then press **OK** or **PUSH JOG**  $\triangleright$ .

### 3 SELECT CHANNEL TO FINE-TUNE

Press **PUSH JOG**  $\Delta$ / $\nabla$  until the channel you want to tune begins blinking, then press **OK** twice.

- The "FRQ" number for that channel starts blinking.

CH	FRQ	CH	FRQ
01	150	07	229
02	165	08	237
03	195	09	355
04	205	10	365
05	213	11	374
06	221	12	384

[ $\Delta$ / $\nabla$ ]: FINE TUNING  
 [OK]: OK  
 [MENU]: EXIT

### 4 PERFORM TUNING

Press **PUSH JOG**  $\Delta$ / $\nabla$  until the picture becomes clearer, then press **OK** or **PUSH JOG**  $\triangleright$ .

- Repeat steps 3 and 4 as necessary.

### 5 RETURN TO NORMAL SCREEN

Press **MENU**.

Before requesting service for a problem, use this chart and see if you can repair the trouble yourself. Small problems are often easily corrected, and this can save you the trouble of sending your video recorder off for repair.

## POWER

SYMPTOM	POSSIBLE CAUSE	CORRECTIVE ACTION
1. No power is applied to the recorder.	<ul style="list-style-type: none"> <li>The mains power cord is disconnected.</li> </ul>	Connect the mains power cord.
2. The clock is functioning properly, but the recorder cannot be powered.	<ul style="list-style-type: none"> <li>"⊖" is displayed on the display panel with Auto Timer set to "OFF".</li> </ul>	Press the <b>TIMER</b> button to turn the "⊖" indicator off.
3. The remote control won't function.	<ul style="list-style-type: none"> <li>The batteries are discharged.</li> </ul>	Replace the dead batteries with new ones.

## TAPE TRANSPORT

SYMPTOM	POSSIBLE CAUSE	CORRECTIVE ACTION
1. The tape does not run during recording.	<ul style="list-style-type: none"> <li>"⏏" is displayed on the display panel.</li> </ul>	Press <b>PLAY</b> to turn the "⏏" indicator off.
2. The tape will not rewind or fast-forward.	<ul style="list-style-type: none"> <li>The tape is already fully rewound or fast-forwarded.</li> </ul>	Check the cassette.

## PLAYBACK

SYMPTOM	POSSIBLE CAUSE	CORRECTIVE ACTION
1. The playback picture does not appear while the tape is running.	<ul style="list-style-type: none"> <li>If you're using the RF OUT connection . . . . . the TV receiver's channel selector is not set to the VIDEO channel.</li> <li>. . . the recorder's VIDEO channel has not been correctly set.</li> <li>If you're using the AV connection, the TV receiver is not set to the AV mode.</li> </ul>	<p>If you are using the RF OUT connection . . . . . set the TV receiver to the VIDEO channel. (☞ pg. 4)</p> <p>. . . Perform "Video Channel Set" (☞ pg. 4)</p> <p>If you are using the AV connection, set the TV to its AV mode.</p>
2. Noise appears during visual search.	<ul style="list-style-type: none"> <li>This is normal.</li> </ul>	
3. Noise appears during normal playback.	<ul style="list-style-type: none"> <li>The automatic tracking mode is engaged.</li> </ul>	Try manual tracking. (☞ pg. 12)
4. Noise appears during slow-motion playback.	<ul style="list-style-type: none"> <li>The automatic tracking mode is engaged.</li> </ul>	Try manual tracking. (☞ pg. 12)
5. Noise appears during still playback.		Press <b>TV PROG +</b> or <b>-</b> a few times to remove the noise bars from the screen.
6. The playback picture is blurred or interrupted while TV broadcasts are clear.	<ul style="list-style-type: none"> <li>The video heads may be dirty.</li> </ul>	Consult your JVC dealer.

## RECORDING

SYMPTOM	POSSIBLE CAUSE	CORRECTIVE ACTION
1. Recording cannot be started.	<ul style="list-style-type: none"> <li>There is no cassette loaded, or the cassette loaded has had its Record Safety tab removed.</li> </ul>	Insert a cassette, or using adhesive tape, reseal the slot where the tab was removed.
2. TV broadcasts cannot be recorded.	<ul style="list-style-type: none"> <li>"F-1" has been selected as the input mode.</li> </ul>	Set to the desired channel.
3. Tape-to-tape editing is not possible.	<ul style="list-style-type: none"> <li>The source (another video recorder, camcorder) has not been properly connected.</li> <li>All necessary power switches have not been turned on.</li> <li>The input mode is not correct.</li> </ul>	<p>Confirm that the source is properly connected.</p> <p>Confirm that all units' power switches are turned on.</p> <p>Set the input mode to "F-1".</p>
4. Camcorder recording is not possible.	<ul style="list-style-type: none"> <li>The camcorder has not been properly connected.</li> <li>The input mode is not correct.</li> </ul>	<p>Confirm that the camcorder is properly connected.</p> <p>Set the input mode to "F-1".</p>



## TIMER RECORDING

SYMPTOM	POSSIBLE CAUSE	CORRECTIVE ACTION
1. Timer recording won't work.	<ul style="list-style-type: none"> <li>The clock and/or the timer have been set incorrectly.</li> <li>The timer is not engaged.</li> </ul>	Re-perform the clock and/or timer settings. Press <b>TIMER</b> and confirm that "⊖" is displayed on the display panel.
2. On-screen timer programming is not possible.	<ul style="list-style-type: none"> <li>Timer recording is in progress.</li> </ul>	Timer programming can't be performed while a timer recording is in progress. Wait until it finishes.
3. "⊖" and "⊖" on the display panel won't stop blinking.	<ul style="list-style-type: none"> <li>The timer is engaged but there's no cassette loaded.</li> </ul>	Load a cassette with the Record Safety tab intact, or cover the hole using adhesive tape.
4. The cassette is automatically ejected, and "⊖" and "⊖" on the display panel won't stop blinking.	<ul style="list-style-type: none"> <li>The loaded cassette has had its Record Safety tab removed.</li> </ul>	Remove the cassette and cover the hole with adhesive tape, or insert a cassette with the Record Safety tab intact.
5. "⊖" blinks for 10 seconds and the Timer mode is disengaged.	<ul style="list-style-type: none"> <li><b>TIMER</b> has been pressed when there are no programs in memory, or the timer record information has been programmed incorrectly.</li> </ul>	Check the programmed data and re-program as necessary, then press <b>TIMER</b> again.
6. The cassette is automatically ejected, the power shuts off and "⊖" and "⊖" won't stop blinking.	<ul style="list-style-type: none"> <li>The end of the tape was reached during timer recording.</li> </ul>	The programme may not have been recorded in its entirety. Next time make sure you have enough time on the tape to record the entire programme.
7. G-CODE does not timer-record properly.	<ul style="list-style-type: none"> <li>The recorder's channel positions have been set incorrectly.</li> </ul>	Refer to "G-CODE Setup" and re-perform the procedure (☞ pg. 18).

## OTHER PROBLEMS

SYMPTOM	POSSIBLE CAUSE	CORRECTIVE ACTION
1. Whistling or howling is heard from the TV during camcorder recording.	<ul style="list-style-type: none"> <li>The camcorder's microphone is too close to the TV.</li> <li>The TV's volume is too high.</li> </ul>	Position the camcorder so its microphone is away from the TV. Turn the TV's volume down.
2. When scanning channels, some of them are skipped over.	<ul style="list-style-type: none"> <li>Those channels have been designated to be skipped.</li> </ul>	If you need the skipped channels, restore them (☞ pg. 29).
3. The channel cannot be changed.	<ul style="list-style-type: none"> <li>Recording is in progress.</li> </ul>	Press <b>PAUSE</b> to pause the recording, change channels, then press <b>PLAY</b> to resume recording.
4. Channel settings that were made manually seem to have changed or disappeared.	<ul style="list-style-type: none"> <li>After the manual settings were made, Auto Channel Set was performed.</li> </ul>	Perform manual setting again.
5. No channels are stored in the recorder's memory.	<ul style="list-style-type: none"> <li>The TV aerial cable was not connected to the recorder when Auto Set Up was performed.</li> </ul>	Connect the TV aerial cable to the recorder properly and turn off the recorder power once, then turn the recorder power back on again. The recorder will try Auto Set Up again (☞ pg. 6).
6. "--:--" is displayed on the front display panel after a power outage.	<ul style="list-style-type: none"> <li>The lithium battery is exhausted.</li> </ul>	Replace the lithium battery with a new one. (☞ pg. 5)

**PLAYBACK**

- Q. **What happens if the end of the tape is reached during playback or search?**  
 A. The tape is automatically rewound to the beginning.  
 .....
- Q. **Can the video recorder indefinitely remain in the still mode?**  
 A. No. It stops automatically after 5 minutes to protect the heads.  
 .....
- Q. **During search, slow, still and frame-by-frame playback, I can't hear any audio. What's the problem?**  
 A. This is normal.  
 .....
- Q. **When returning from multi-speed search to normal playback, the picture is disturbed. Should I be concerned about this?**  
 A. No, it is normal.  
 .....
- Q. **Noise bars appear during multi-speed search. What's the problem?**  
 A. This is normal.  
 .....
- Q. **Other than preventing further recording, what effect does removing the Record Safety tab have?**  
 A. It disables marking of index codes.  
 .....
- Q. **Sometimes, during Index Search, the video recorder can't find the programme I want to see. Why not?**  
 A. There may be index codes too close together.  
 .....

**RECORDING**

- Q. **When I pause and then resume a recording, the end of the recording before the pause is overlapped by the beginning of the continuation of recording. Why does this happen?**  
 A. This is normal. It reduces distortion at the pause and resume points.  
 .....
- Q. **Can the video recorder indefinitely remain in the Record-Pause mode?**  
 A. No. The video recorder goes to its Stop mode automatically after 5 minutes to protect the heads.  
 .....
- Q. **What happens if the tape runs out during recording?**  
 A. The video recorder automatically rewinds it to the beginning.  
 .....

**TIMER RECORDING**

- Q. **"⦿" and "⊖" remain lit on the display panel. Is there a problem?**  
 A. No. This is a normal condition for a timer recording in progress.  
 .....
- Q. **Can I program the timer while I'm watching a tape or a TV broadcast?**  
 A. You won't see the picture as it is replaced by the on-screen menu, but the audio from the program or tape you're viewing can be heard.  
 .....
- Q. **Is it possible to timer-record a TV programme broadcast in 2000?**  
 A. Yes, it is possible.  
 .....

**ATTENTION:**

This recorder contains microcomputers. External electronic noise or interference could cause malfunctioning. In such cases, switch the recorder off and unplug the mains power cord. Then plug it in again and turn the recorder on. Take out the cassette. After checking the cassette, operate the unit as usual.

FRONT VIEW

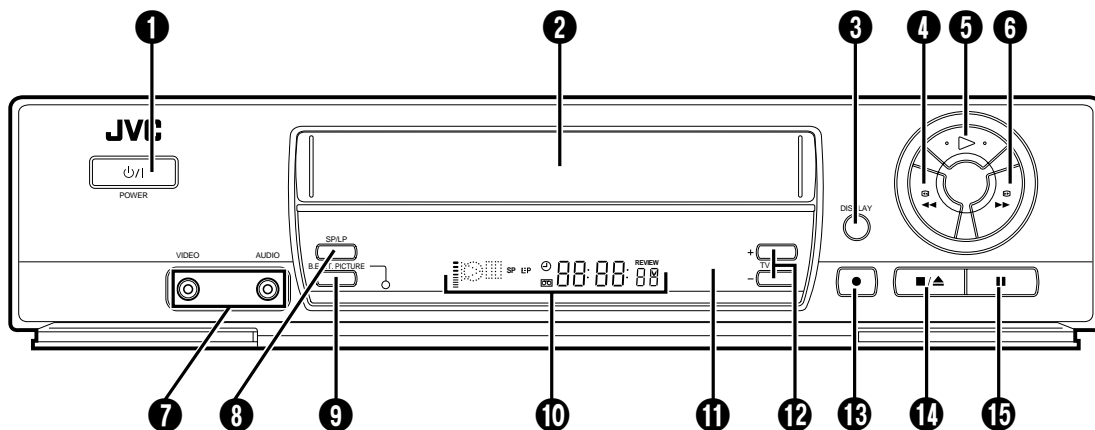

- ❶ POWER  $\phi$ /I Button  $\hookrightarrow$  pg. 5
- ❷ Cassette Loading Slot
- ❸ DISPLAY Button  $\hookrightarrow$  pg. 15
- ❹ Rewind [REW] Button  $\hookrightarrow$  pg. 10, 11
- ❺ PLAY Button  $\hookrightarrow$  pg. 10
- ❻ Fast Forward [FF] Button  $\hookrightarrow$  pg. 10, 11
- ❼ VIDEO/AUDIO Input Connectors  $\hookrightarrow$  pg. 27
- ❽ SP/LP Button  $\hookrightarrow$  pg. 14
- ❾ B.E.S.T. Picture Button  $\hookrightarrow$  pg. 16
- ❿ B.E.S.T. Picture Indicator  $\hookrightarrow$  pg. 16
- ⓫ Display Panel  $\hookrightarrow$  pg. 36
- ⓬ Infrared Beam Receiving Window
- ⓭ TV PROG +/- Buttons  $\hookrightarrow$  pg. 14
- ⓮ RECORD Button  $\hookrightarrow$  pg. 14
- ⓯ STOP/EJECT Button  $\hookrightarrow$  pg. 10
- ⓰ PAUSE Button  $\hookrightarrow$  pg. 11

REAR VIEW

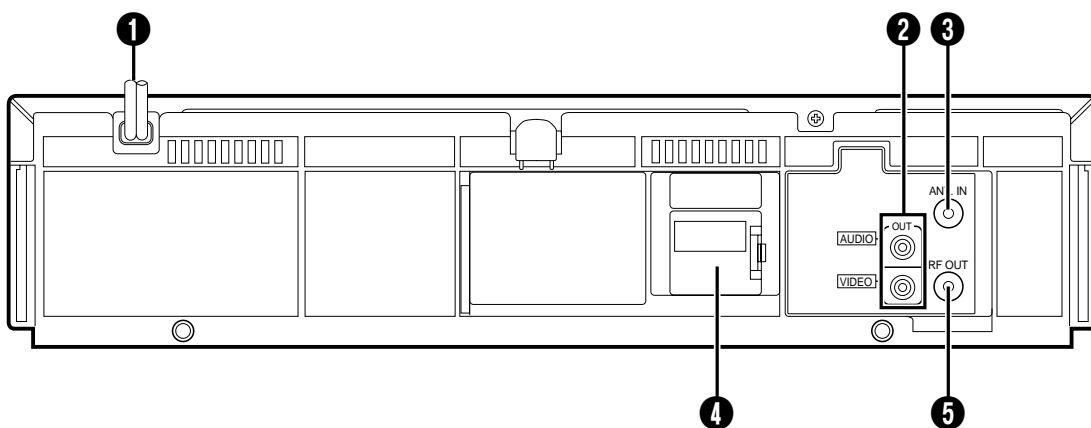

- ❶ Mains Power Cord  $\hookrightarrow$  pg. 3
- ❷ AUDIO/VIDEO OUT Connectors  $\hookrightarrow$  pg. 3, 26
- ❸ ANT. IN Connector  $\hookrightarrow$  pg. 3
- ❹ Lithium Battery Compartment  $\hookrightarrow$  pg. 5
- ❺ RF OUT Connector  $\hookrightarrow$  pg. 3

DISPLAY PANEL

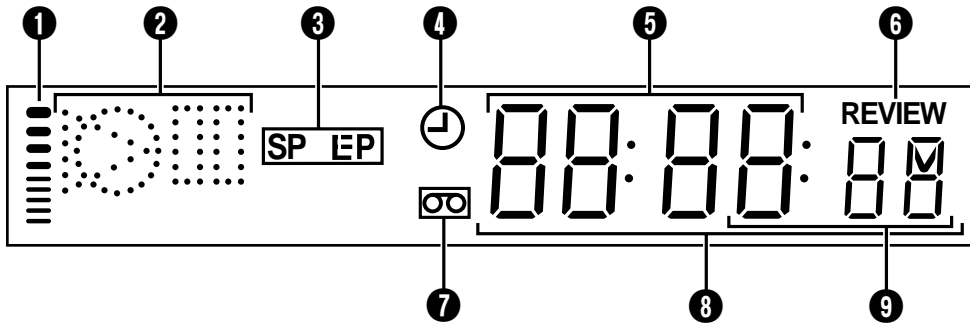

- ❶ B.E.S.T. Picture System Display pg. 17
- ❷ Symbolic Mode Indicators

PLAY: VARIABLE SHUTTLE SEARCH:		STILL:	
		SLOW:	
		RECORD:	
		RECORD PAUSE:	

- ❸ Tape Speed Indicators pg. 14
- ❹ "Timer" Indicator pg. 21, 23
- ❺ Channel Display  
Clock Display
- ❻ Instant REVIEW Indicator pg. 13
- ❼ "Cassette Loaded" Mark
- ❽ Count Display
- ❾ Mode Display (F-1)

## REMOTE CONTROL

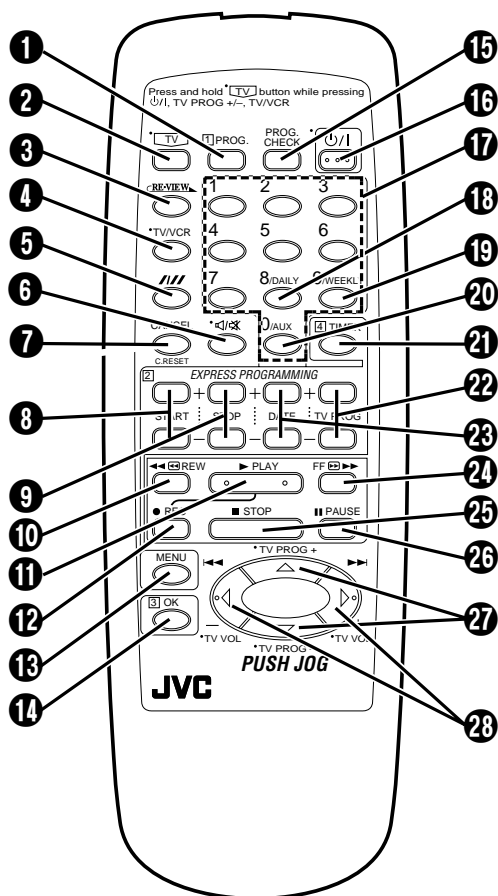

- 1 PROG. Button (See pg. 20)
  - 2 TV Button (See below)
  - 3 REVIEW Button (See pg. 13)
  - 4 TV/VCR Button (See below)
  - 5 Recording Speed [SP/LP/EP] Button (See pg. 14)
  - 6 (TV Muting) Button (See below)
  - 7 CANCEL Button (See pg. 20)
  - 8 START +/- Button (See pg. 22)
  - 9 STOP +/- Button (See pg. 22)
  - 10 Rewind [REW] Button (See pg. 10)
  - 11 PLAY Button (See pg. 10)
  - 12 Record [REC] Button (See pg. 14)
  - 13 MENU Button (See pg. 8)
  - 14 OK Button (See pg. 4)
  - 15 PROG. CHECK Button (See pg. 20)
  - 16 POWER +/- Button (See pg. 5)
  - 17 NUMBER Buttons (See pg. 14)
  - 18 DAILY Timer Recording Button (See pg. 21)
  - 19 WEEKLY Timer Recording Button (See pg. 21)
  - 20 "AUX" Mode Select Button (See pg. 27)
  - 21 TIMER Button (See pg. 21, 23)
  - 22 TV PROG +/- Button (See pg. 14, 22)
  - 23 DATE +/- Button (See pg. 22)
  - 24 Fast-Foward [FF] Button (See pg. 10)
  - 25 STOP Button (See pg. 10)
  - 26 PAUSE Button (See pg. 11)
  - 27 PUSH JOG +/- Button (See pg. 6)
  - 28 PUSH JOG <<>>>> (<>) Button (See pg. 11, 13)
- TV Volume [VOL] +/- Button (See below)

Buttons with a small dot on the left side of the name can also be used to operate your JVC TV while holding down the TV button.

This remote control transmits A code signals only; it is not applicable to B code signals.

### How To Use

The remote control can operate most of your video recorder's functions, as well as basic functions of JVC TV sets. (See below.)

- Point the remote control toward the sensor window.
- The maximum operating distance of the remote control is about 8 m.

### Operating JVC TVs

To operate your TV, while holding down TV, press the corresponding button: POWER +/-, TV/VCR, TV PROG +/-, TV VOL +/-, (TV Muting).

### NOTES:

- When inserting the batteries, be sure to insert in the correct directions as indicated under the battery cover.
- Depending on the type of JVC TV, there may be cases where some or all functions cannot be operated using the remote control.
- If the remote control doesn't work properly, remove its batteries, wait a short time, replace the batteries and then try again.

**GENERAL**

Power requirement	: AC 220 – 240 V~, 50/60 Hz
Power consumption	: 18W
Temperature	
Operating	: 5°C to 40°C
Storage	: -20°C to 60°C
Operating position	: Horizontal only
Dimensions (WxHxD)	: 400 x 94 x 277 mm
Weight	: 3.4 kg
Format	: VHS standard
Maximum recording time	
(SP)	: 240 min. with E-240 video cassette
(LP)	: 480 min. with E-240 video cassette

**VIDEO/AUDIO**

Signal system	: PAL-type colour signal and CCIR monochrome signal, 625 lines 50
Recording system	: Rotary two-head helical scan system
Signal-to-noise ratio	: 45 dB
Horizontal resolution	: 250 lines
Frequency range	: 70 Hz to 10,000 Hz
Input/Output	: RCA connectors (IN x 1, OUT x 1)

**TUNER/TIMER**

TV channel storage capacity	: 99 positions (+AUX position)
Tuning system	: Frequency synthesized tuner
Channel coverage	: VHF (Low) 42 – 175 MHz (High) 175 – 470 MHz UHF 470 – 870 MHz
Aerial output	: UHF channels (Adjustable 28 – 60)
Memory backup time	: Approx. 6 months Estimated figure based on supplied fresh battery; actual performance may differ.

**ACCESSORIES**

Provided accessories	: RF cable, Infrared remote control unit, "R6/UM-3" battery x 2, Lithium battery CR2025
----------------------	--

*Specifications shown are for SP mode unless otherwise specified.*

*Design and specifications subject to change without notice.*



